



PARTS LISTS AND EXPLODED DIAGRAMS

SUPPLEMENT 11

Edited by Samuel J. Baum

Diagrams by Steven Gugel

Notice to the User

This supplement is designed to fit with two different publications, the Lionel Service Manual by Lionel Trains, Inc. and Lionel Parts Lists and Exploded Diagrams published by Greenberg Publishing Company, Inc. Each page has two page numbers. The number for the Lionel Service Manual by Lionel is indicated by parenthesis, i.e., (M-1). The number which applies to Lionel Parts Lists and Exploded Diagrams by Greenberg Publishing is above the parenthesis, i.e. S11:20-1.

Users should note that the drawings in this Supplement are the first to pertain to Lionel's new line of Large Scale Trains. To accommodate this we have designated several new section numbers in the index to Lionel Parts Lists and Exploded Diagrams by Greenberg Publishing Company, Inc. These new sections are: #20 for the Large Scale Locomotives; #21 for the Large Scale Caboose; and #22 for the Large Scale Gondolas. Users of the Lionel Service Manual by Lionel Trains, Inc. should refer to the appropriate index page in this Supplement for complete insertion instructions.

Users should also note that the last page of this supplement should be inserted into Supplement 10 and is designed to take the place of previously issued pages S10:11-1 and 11-2 (F-75 and F-75-2 in the Lionel Service Manual). Lionel has made a change to improve their product, and we have revised this sheet in accordance with their instructions.

We recommend that readers with the Lionel Service Manual insert the pages according to the numbers in the parenthesis (see instructions on Lionel Service Manual index page). On the other hand, we recommend that readers with Lionel Parts Lists and Exploded Diagrams keep the pages as a set and insert them into a new binder. Binders to match the 1970-1986 binder are available from Greenberg Publishing Company, Inc. for \$7.50 plus \$2.50 shipping and handling. A comprehensive index to the Lionel Parts Lists and Exploded Diagrams will be issued once a year, and will take the place of the index at the front of the original 1970-1986 manual.

Authorized by Lionel Trains, Inc.

Published by Greenberg® Publishing Company, Inc.

Copyright © 1988 by Lionel Trains, Inc.

All rights reserved.

Reproduction of the whole or any part of the contents
without written permission is prohibited.

Manufactured in the United States of America

Published by Greenberg Publishing Company, Inc.

7566 Main Street
Sykesville, MD 21784
(301) 795-7447

Greenberg Publishing Company, Inc. offers the world's largest selection of Lionel, American Flyer and other toy train publications as well as a selection of books on other collectibles such as toys, marbles, and dollhouses. Our catalogue is available for \$2.00, refundable with your order.

Greenberg Shows, Inc. sponsors the world's largest public model railroad shows. The shows feature extravagant operating model railroads for N, HO, O, Standard and 1 Gauges as well as a huge marketplace for buying and selling nearly all model railroad equipment. The shows also feature, a large selection of dollhouses and dollhouse furnishings. Shows are currently offered in metropolitan Boston, Long Island in New York, Philadelphia, Pittsburgh, Baltimore, Norfolk, New Jersey and Florida. To receive the current show listing, please send a self-addressed stamped envelope marked "Train Show Schedule" to the address above.

ISBN 0-89778-106-6

INDEX TO LIONEL PARTS LISTS AND EXPLODED DIAGRAMS SUPPLEMENT 11

ALPHABETICAL INDEX

Item	Drawing
LARGE SCALE LOCOMOTIVES	
Steam Locomotives	
0-6-0 Type	S11:20-1
w/DC Can Motor	thru
8-85100 Penn	S11:20-4
8-85101 D & RG	
LARGE SCALE CABOSES	
Square Window Units	S11:21-1,2
8-87700 Penn	
8-87701 D & RG	
LARGE SCALE GONDOLAS	
8-87400 Penn	S11:22-1
8-87401 D & RG	
(Note: This is a generic drawing and will also be usable for other future Large Scale Gondolas.)	

NUMERICAL INDEX

Item	Drawing
8-85100	S11:20-1 thru 20-4
8-85101	S11:20-1 thru 20-4
8-87400	S11:22-1
8-87401	S11:22-1
8-87700	S11:21-1,2
8-87701	S11:21-1,2

INSTRUCTIONS FOR ADDING LARGE SCALE SERVICE MANUAL SHEETS
TO EARLY PUBLICATION.
Issued to Lionel dealers, by Lionel Service.

Users of the early Lionel Service Manual should note that in this Supplement begins the first drawings for Lionel's new Large Scale Trains. New sections for these trains will be designated as the need arrives. For the purposes of this manual the new sections are:

- M for Large Scale Steam Locomotives.
- P for Large Scale Rolling Stock.

All Large Scale pages should be installed in the HO section of your manual which also contains American Flyer S Gauge.

Install Large Scale Steam Locomotives in HO Power Packs section.

Install Large Scale Rolling Stock in HO Wiring Diagram section.

Re-label the section tabs accordingly.

INDEX FOR LARGE SCALE TRAINS FOR LIONEL SERVICE MANUAL
by Lionel Service

DESCRIPTION	DRAWING PAGE NUMBER
LARGE SCALE LOCOMOTIVES	
8-85100 Pennsylvania, 0-6-0 Locomotive	M-1, M-2, M-3, M-4
8-85101 Denver & Rio Grand, 0-6-0 Locomotive	M-1, M-2, M-3, M-4
LARGE SCALE ROLLING STOCK	
8-87700 Caboose Pennsylvania	P-1, P-2
8-87701 Caboose Denver & Rio Grand	P-1, P-2
8-87400 Gondola Pennsylvania	P-3
8-87401 Gondola Denver & Rio Grand	P-3

LARGE SCALE 0-6-0 LOCOMOTIVE

8-85100 Pennsylvania

8-85101 Denver & Rio Grande

(Page 1 of 4)

818-5101-065
Window Shell



818-5101-390
Back Head Gauge Lever

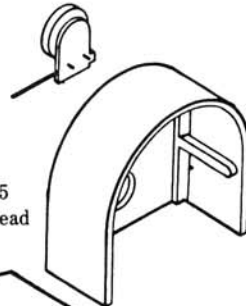

818-5101-105
Boiler Back Head

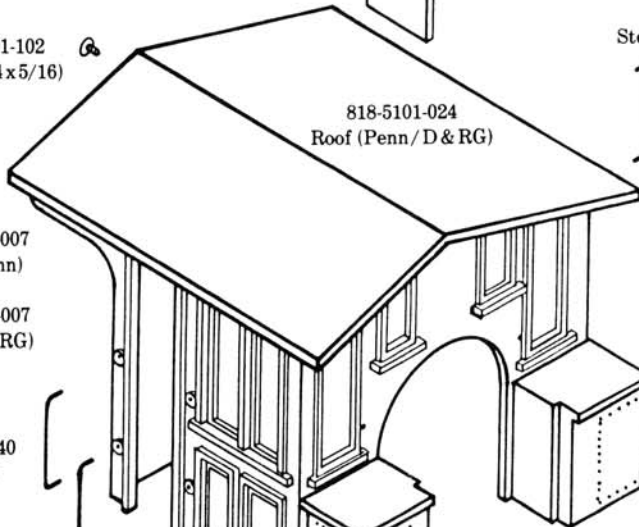

818-5101-102
Screw (#4x5/16)

818-5101-024
Roof (Penn/D & RG)

818-5100-007
Cab (Penn)

818-5101-007
Cab (D & RG)

818-5101-140
Grabrail

818-5101-045
Tender Tank Rail—Long

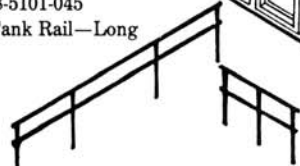

818-5101-055
Tender Tank Rail—Short



818-5101-016
Wood Load (D & RG)



818-5100-016
Coal Load (Penn)

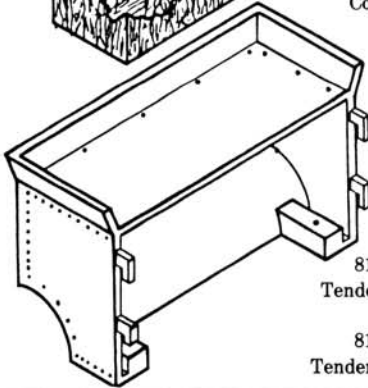

818-5100-017
Tender Tank (Penn)

818-5101-017
Tender Tank (D & RG)

818-5101-350
Whistle



818-5101-300
Steam Dome Top



818-5101-164
Steam Dome (D & RG)



818-5100-164
Steam Dome (Penn)



818-5101-310
Steam Dome Bottom



818-5101-360
Bell



818-5101-370
Bell Bracket

818-5101-320
Sand Dome Top

818-5101-037
Sand Dome (D & RG)

818-5100-037
Sand Dome (Penn)

818-5101-330
Sand Dome Bottom

818-5101-020
Boiler Band (Brass)

818-5101-102
Screw (#4x5/16)

818-5101-124
Boiler (D & RG)

818-5100-124
Boiler (Penn)

818-5101-070
Stanchions

818-5101-040
Handrail

818-5101-070
Stanchions

818-5101-040
Handrail

818-5101-012
Screw (#8x1)
(Steam Dome Mtg)

818-5101-132
Screw (#6x7/8)
(Boiler Weight Mtg)

818-5101-012
Screw (#8x1)
(Sand Dome Mtg)

818-5101-569
Weight Boiler Assy

NOTE: Although Sand Dome and Steam Dome bottoms have different part numbers, they are interchangeable pieces.

LARGE SCALE 0-6-0 LOCOMOTIVE
8-85100 Pennsylvania
8-85101 Denver & Rio Grande

(Page 2 of 4)

818-5101-171
Headlight Body Assy (D & RG)
 818-5100-177
Headlight Body Assy (Penn)

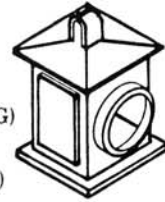

818-5101-804
Smoke Box & Stack (D & RG)

818-5101-284
Smoke Box Front (D & RG)

818-5100-804
Smoke Box/Stack & Front (Penn)

818-5101-138
Bulb & Socket Assy

818-5101-230
Headlight Bracket

818-5101-502
Motor & Worm Gear Assy

818-5101-550
Motor

818-5101-551
Worm

818-5101-042
Drive Studs

818-5101-023
Builders Plate

818-5101-022
Screw (#6x1/4)

818-5101-023
Builders Plate

818-5101-307
Number Board (D & RG)

818-5100-307
Number Board (Penn)

818-5101-750
Yoke

818-5101-620
Cylinder Back

818-5101-630
Grease Cup

818-5101-150
Reversing Rod

818-5101-604
Box Top Steam Chest

818-5101-130
Crosshead Guide

818-5101-610
Cylinder Front

818-5101-225
Frame

818-5101-420
Link Pin

818-5101-410
Flagstaff

818-5101-035
Rear Spring

818-5101-115
Front Spring

818-5101-700
Drawbar

818-5101-295
Step

818-5101-072
Screw (#6x1/2)

818-5101-710
Drive Rod

818-5101-122
Screws (Motor Mtg)

818-5101-072
Screw (Cab Mtg)

818-5101-404
Cowcatcher (D & RG)

818-5100-404
Cowcatcher (Penn)

818-5101-730
Side Rod

818-5101-720
Crosshead (RH)

818-5101-082
Shoulder Screw

818-5101-295
Step

818-5101-052
Shoulder Screw

818-5101-062
Shoulder Screw

818-5101-559
Chassie Weight

LARGE SCALE 0-6-0 LOCOMOTIVE

8-85100 Pennsylvania

8-85101 Denver & Rio Grande

(Page 3 of 4)

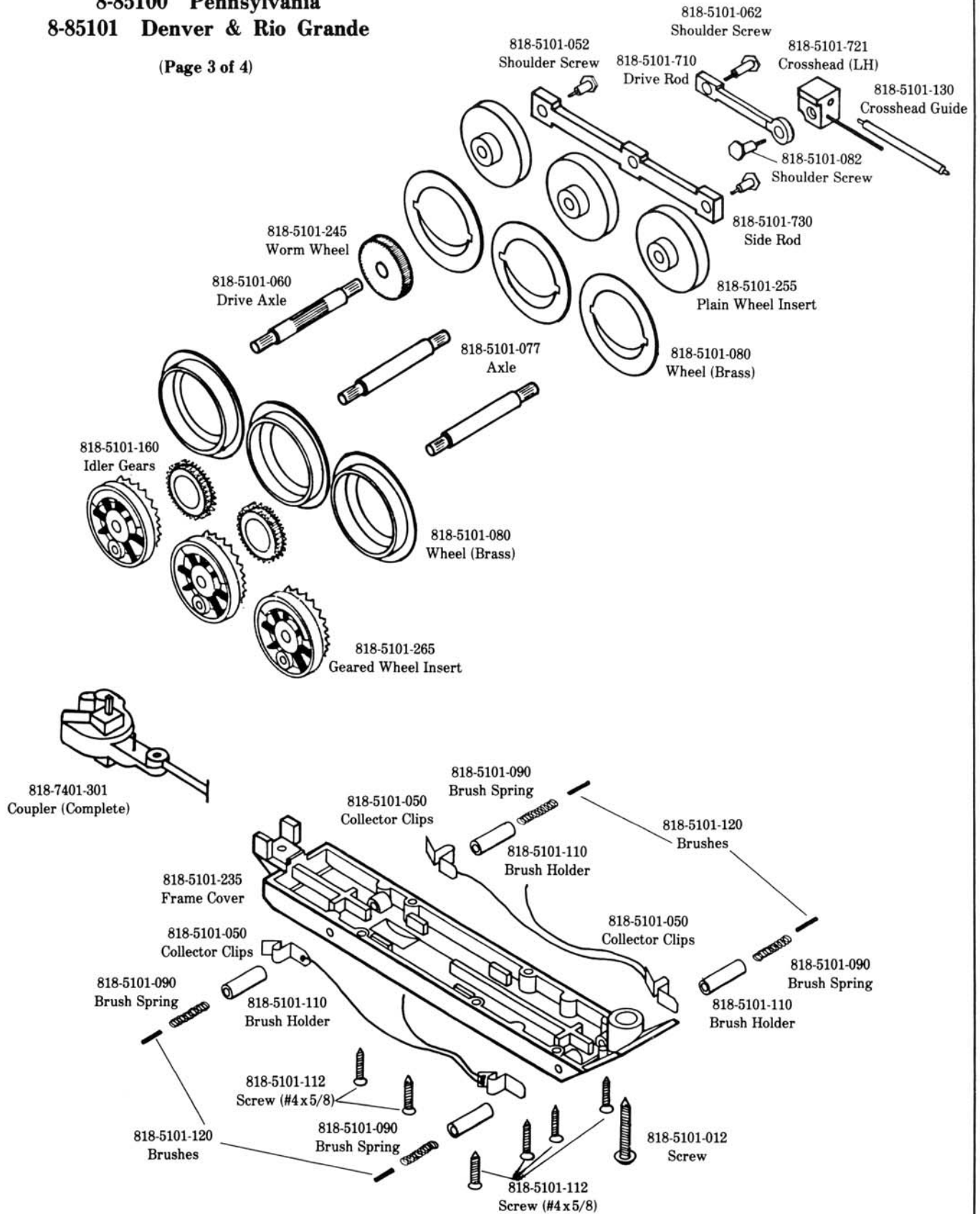

LARGE SCALE 0-6-0 LOCOMOTIVE

8-85100 Pennsylvania

8-85101 Denver & Rio Grande

(Page 4 of 4)

Several items on the Large Scale Locomotives diagrams which are broken down into their component parts are also available as complete assemblies. Below is an alphabetical listing of those assemblies and their parts. If a complete assembly is desired, use the assembly number when ordering; if only the parts are needed, use the parts number. See drawings for more information.

818-5100-900 BOILER ASSY — PENN

818-5101-900 BOILER ASSY — D & RG

818-5101-012 Screw #8x1
818-5101-020 Boiler band (brass)
818-5100-037 Steam dome — Penn
818-5101-037 Steam dome — D & RG
818-5101-070 Stanchion
818-5101-105 Boiler back head
818-5100-124 Boiler (dark green) — Penn
818-5101-125 Boiler (light blue) — D & RG
818-5100-164 Sand dome (dark green) — Penn
818-5101-164 Sand dome (light blue) — D & RG
818-5101-300 Steam dome top
818-5101-310 Steam dome bottom
818-5101-320 Sand dome top
818-5101-350 Whistle
818-5101-360 Bell
818-5101-370 Bell bracket

818-5101-500 CHASSIE ASSY

818-5101-050 Collector clip
818-5101-090 Brush spring
818-5101-110 Brush holder
818-5101-112 Screw #4x5/8
818-5101-120 Brush
818-5101-122 Screw #5x6
818-5101-160 Idler gear
818-5101-225 Frame
818-5101-235 Frame cover
818-5101-502 Motor & worm gear assy
818-5101-503 Geared wheel & drive axle assy
818-5101-504 Geared wheel & axle assy
818-5101-505 Plain wheel assy
818-5101-559 Chassie weight
818-5101-301 Coupler assy

818-7401-301 COUPLER ASSY

818-7401-310 Coupler spring
818-7401-325 Coupler arm
818-7401-335 Coupler pin
818-7401-345 Hinge pin
818-7401-355 Knuckle

818-5100-400 COWCATCHER ASSY — PENN

818-5101-400 COWCATCHER ASSY — D & RG

818-5100-404 Cowcatcher — Penn
818-5101-404 Cowcatcher — D & RG
818-5101-410 Flagstaff
818-5101-420 Link pin
818-5101-700 Drawbar

818-5101-200 DRIVE ROD & CROSSHEAD ASSY (RIGHT HAND)

818-5101-082 Shoulder screw (hex head)
818-5101-710 Drive rod (plated)
818-5101-720 Crosshead (RH)

818-5101-201 DRIVE ROD & CROSSHEAD ASSY (LEFT HAND)

818-5101-082 Should screw (hex head)
818-5101-710 Drive rod (plated)
818-5101-721 Crosshead (LH)

818-5101-506 GEARED WHEEL ASSY

818-5101-080 Wheel (brass)
818-5101-265 Geared wheel insert

818-5101-504 GEARED WHEEL & AXLE ASSY

818-5101-077 Axle (ends knurled)
818-5101-505 Plain wheel assy
818-5101-506 Geared wheel assy

818-5101-503 GEARED WHEEL & DRIVE AXLE ASSY

818-5101-060 Drive axle (ends & center knurled)
818-5101-245 Worm wheel
818-5101-505 Plain wheel assy
818-5101-506 Geared wheel assy

818-5101-502 MOTOR & WORM GEAR ASSY

818-5101-550 Motor
818-5101-551 Worm gear

818-5101-505 PLAIN WHEEL ASSY

818-5101-080 Wheel (brass)
818-5101-255 Plain wheel insert

818-5100-800 SMOKE BOX ASSY — PENN

818-5101-800 SMOKE BOX ASSY — D & RG

818-5101-022 Screw #6x1/2 (brass)
818-5101-023 Builder's plate
818-5101-042 Drive studs
818-5101-138 Bulb & socket assy w/12" leads
818-5100-177 Headlight body assy — Penn
818-5101-171 Headlight body assy — D & RG
818-5101-230 Headlight bracket
818-5101-284 Smoke box front (silver) — D & RG
818-5101-804 Smoke box & stack — D & RG
818-5100-804 Smoke box/stack & front — Penn

818-5101-600 STEAMCHEST ASSY

818-5101-604 Box top steam chest (painted)
818-5101-610 Cylinder front
818-5101-620 Cylinder back
818-5101-630 Grease cup

LARGE SCALE CABOOSE
8-87700 Pennsylvania
8-87701 Denver & Rio Grande

(Page 1 of 2)

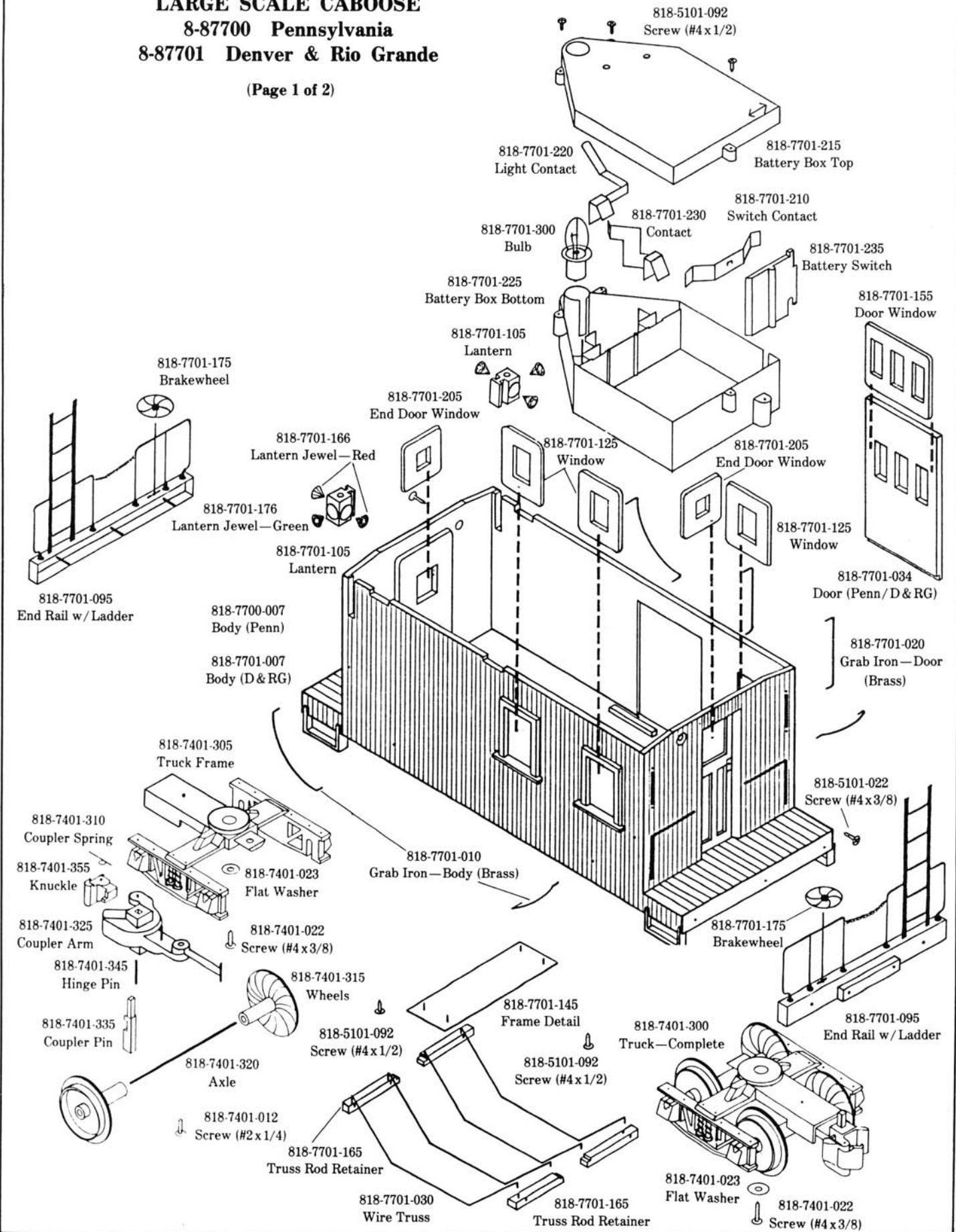

LARGE SCALE CABOOSE
8-87700 Pennsylvania
8-87701 Denver & Rio Grande

(Page 2 of 2)

818-7701-075
Grab Rail

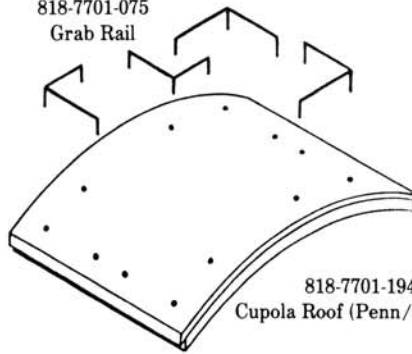

818-7701-194
Cupola Roof (Penn/D & RG)

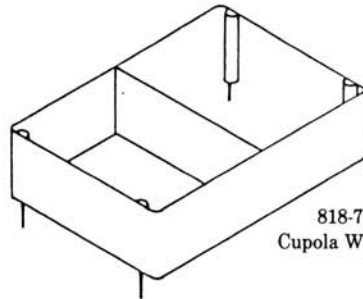

818-7701-085
Cupola Window Shell

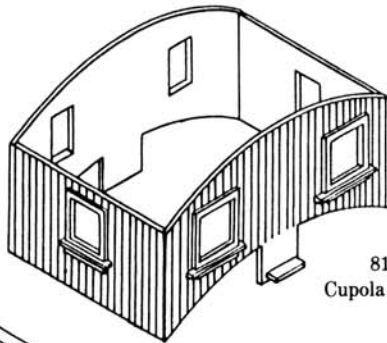

818-7701-024
Cupola (Penn/D & RG)

818-7701-055
Catwalk—Short (Penn/D & RG)

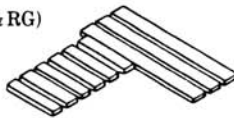

818-7701-065
Smoke Stack



818-7701-045
Catwalk—Long (Penn/D & RG)

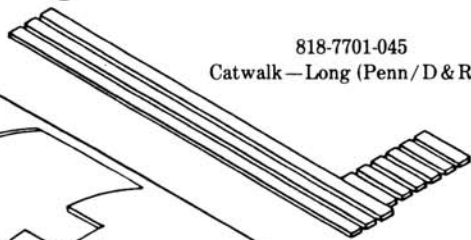

818-7401-302
Wheel and Axle Assy



818-7401-301
Coupler—Complete

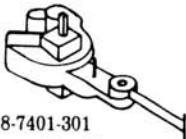

Trucks, couplers, and wheel assemblies are available as complete units. However, the individual parts which make up the units may also be obtained separately. Both alternatives have been pictured on this drawing and item numbers have been provided.

818-7700-017
Roof (Penn)

818-7701-013
Roof (D & RG)

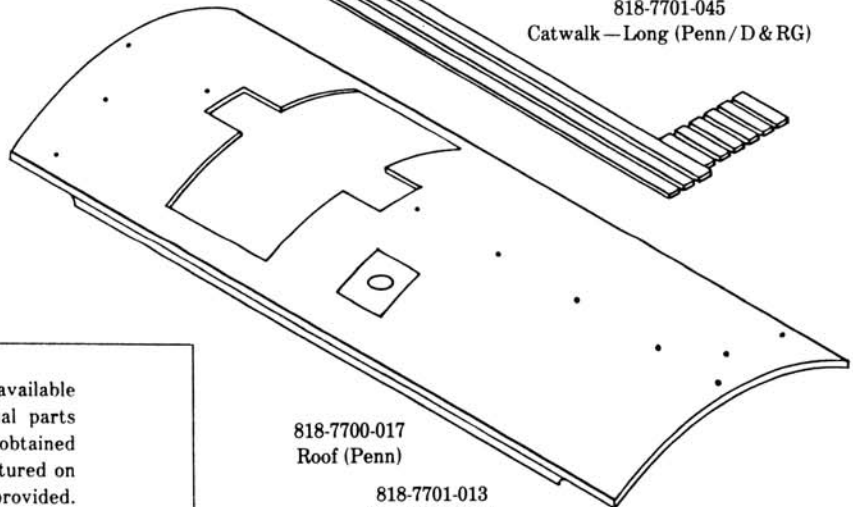

LARGE SCALE GONDOLA

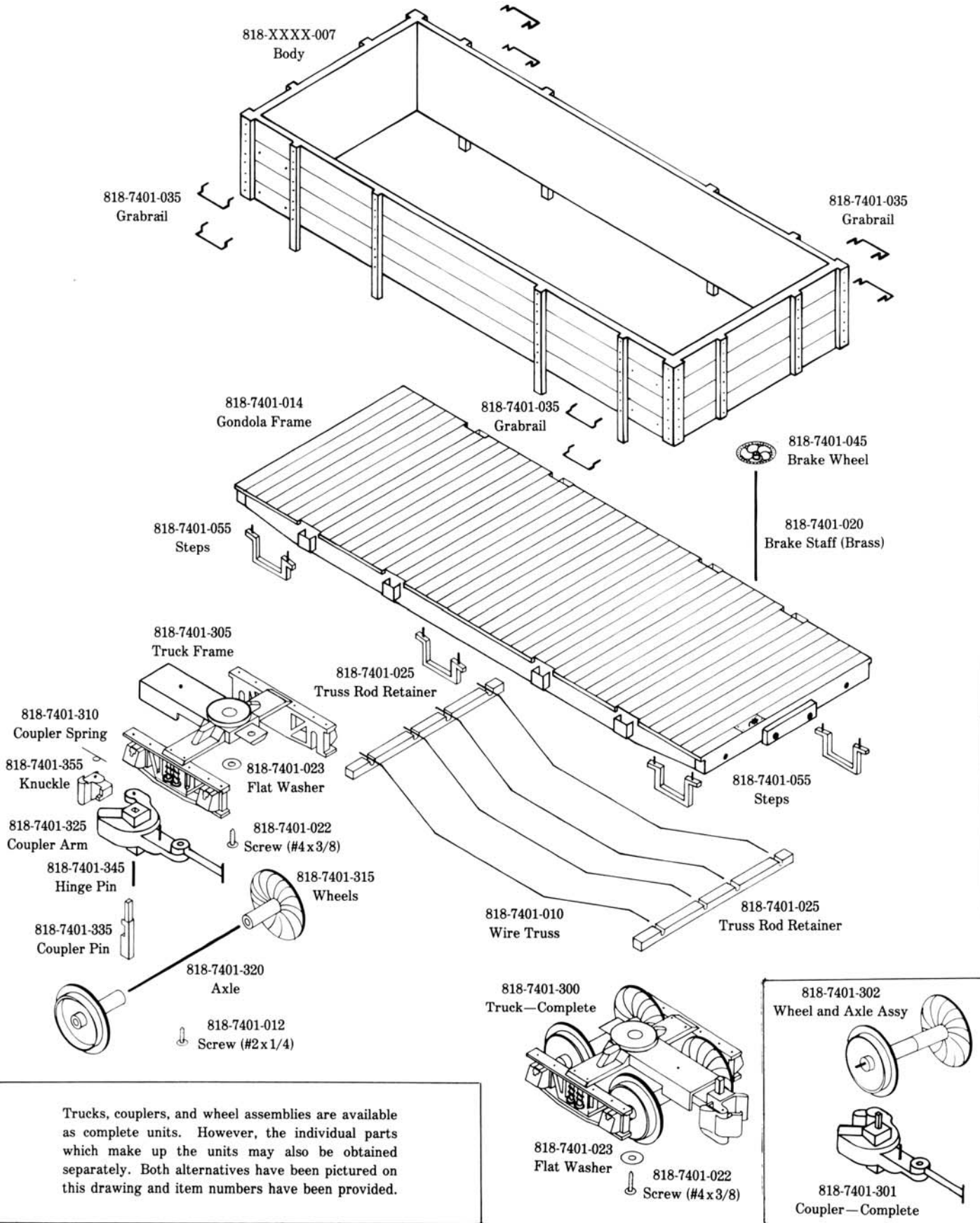

Trucks, couplers, and wheel assemblies are available as complete units. However, the individual parts which make up the units may also be obtained separately. Both alternatives have been pictured on this drawing and item numbers have been provided.

OPERATING HORSE AND CATTLE CAR

9224 Horse Car
1-9800 Cattle Car

