

HOW TO OPERATE  
**LIONEL TRAINS**  
AND  
**ACCESSORIES**  
FOR  
"O27" "O" SUPER "O"



Price \$1.00

**THE LIONEL TOY CORPORATION**  
THE LIONEL SERVICE COMPANY. HOFFMAN PLACE. HILLSIDE. N.J.

## PLEASE—READ THIS FIRST

### Never Connect Your Layout Directly to a Household Electric Outlet. Always Use a Transformer.

Lionel train outfits are designed for use with Lionel "Multi-Control" transformers. These transformers change the line voltage available in your house to low voltage suitable for Lionel trains and accessories. "Multi-Control" transformers are equipped with built-in controls for regulating train speed, stopping and reversing locomotives, and blowing the train whistle.

Most Lionel outfits include a transformer which is suitable for operating the train plus a few lights or signals. However, a transformer to fit your requirements may be purchased separately from your dealer.

### Make Sure That Your Transformer Rating (Volts and Cycles) Corresponds to Your House Electric Supply.

Most places in the United States use 110-115 volt, 60-cycle

current, but there are a number of exceptions. In areas where special conditions exist, special transformers for these are available from your Lionel dealer. If you are in doubt about the rating of your household supply, consult your electric company.

### If You Happen to Have Direct Current (D.C.), a Transformer Cannot Be Used.

Low voltage direct current such as is available from automobile storage batteries, or from d.c. generators used in some rural areas can be used with special control units instead of transformers.

High voltage direct current such as is used in some lower Manhattan areas in New York City requires the use of an INVERTER in addition to the transformer. See the section "Your Power Supply."

## IMPORTANT

Lionel Transformers have been approved by the Underwriters Laboratories and are carefully tested to assure proper performance. The Nos. 1015, 1016 and 1026 transformers do not have a built-in circuit breaker. Therefore, it is recommended that a separate circuit breaker such as Lionel No. 91 or 92 be used to protect these transformers from possible harm from accidental short circuits caused by derailments or improper wiring.

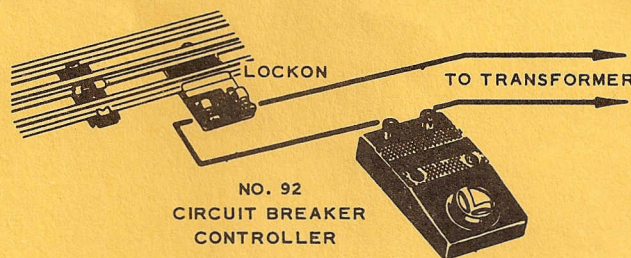

## INTRODUCTION

FEW hobbies in the world offer as much fun as model railroading. Here, in miniature, are all the color and excitement of real railroading, with speedy passenger trains and fast freights making runs through cities and towns and open countryside.

If you are a beginner in this fascinating pastime and this is your first Lionel outfit you will need a few simple directions to set up your layout and to run your train. The first part of this booklet, "How to Assemble and Operate Your Lionel Outfits", contains all the directions you need in order to enjoy any simple standard outfit.

If you are like most model railroaders we know, you will soon add to your original outfit, perhaps a pair of switches and some extra track, maybe a semaphore or a gateman to guard your grade crossing. Then you will need to know something about voltage requirements of various Lionel railroad accessories, about the capacity and limitations of your transformer and the best methods of wiring up your layout and accessories. All this information, in a condensed form, is available in the second part of this booklet.

The third part of the booklet will help start you off on a project which is the ambition of all model railroaders—"How to Build a Model Railroad". Here is a discussion on how to select a space for a permanent layout; how to design track arrangement to fit the available space; how to construct the framework; how to landscape and decorate your railroad so that it becomes an actual operating railroad in miniature.

Like all fine mechanical equipment, your Lionel outfit deserves good care. If properly cared for, your Lionel equipment will give many years of service and enjoyment. Information that should enable you to find and eliminate trouble spots, to do simple maintenance and to keep your equipment in tip-top condition is contained in the last part of the booklet, "How to Take Care of Lionel Trains".

All Contents Copyrighted 1965 by  
THE LIONEL TOY CORPORATION  
Hoffman Place, Hillside, New Jersey



# TABLE OF CONTENTS

## **PART ONE**

### **HOW TO OPERATE YOUR LIONEL OUTFIT**

#### **HOW TO ASSEMBLE YOUR LAYOUT**

Check Your Equipment—Assembling the Track—Various Kinds of Track—Attach the Lockon to Track—Connect Lockon to Transformer—Connecting Transformers to "0" and "027" Track—Assembling "Super-0" Track—"Super-0" Track Lockons—"Super-0" Track Electrical Connections—"Super-0" Uncoupling Unit and Operating Blades—Place Train on the Track—Short Circuit Trouble Spots

Page 1  
2  
3

#### **HOW TO OPERATE THE TRAIN**

Regulating Train Speed—Reversing the Locomotive—How to Disconnect Reversing Mechanism—Items with Special Reversing Methods—Sounding the Whistle and Horn—"Magne-Traction" Locomotives—"Smoke" Locomotives—Coupling and Uncoupling

Page 4  
5

#### **AUTOMATIC OPERATING CARS**

Cars Using Contact Slide Shoes—Table of Operating Cars—OTC Contactor—No. 3661 Lumber Car—No. 3376 Operating Giraffe Car—No. 3359 Twin Bin Dump Car—No. 3356 Horse Car—No. 55 Tie Unloading Car—No. 3927 Track Cleaning Car

Page 5  
6  
7

## **PART TWO**

### **MODEL RAILROAD ACCESSORY EQUIPMENT**

#### **AUTOMATIC SIGNALING**

Table of Accessory Equipment—Connecting Accessories in "Parallel"—Automatic Operation by Pressure Contactors—Automatic Operation by Insulated Control Rails—No. 140 Banjo Signal—No. 353 Control Signal—No. 252 Crossing Gate—No. 145 Gateman—No. 445 Switch Tower—No. 154 Highway Signal—No. 151 Semaphore

Page 7  
8  
9  
10

#### **OPERATING ACCESSORIES**

No. 148 Dwarf Signal—No. 350 Transfer Table—No. 264 Forklift Platform—No. 464 Lumber Mill—No. 128 Newsstands—No. 334 Dispatching Board

Page 10  
11  
12

#### **SWITCHES, CROSSINGS AND TRACK**

No. 022 Switches—No. 1122 Switches—"Super-0" Switches—Manually Operated Switches—Controlling Signals with Switch Mechanism—Special Uses of Non-Derailing Switch Mechanism—Track Crossings—Various Kinds of Track—How to Cut Track—How to Mount Track on a Platform—Lionel Track Pliers—How to Make Insulated Track Sections—Intermixing Track and Equipment—Track Transition Pieces for "Super-0" Track

Page 13  
14  
15  
16

## **PART THREE**

### **ADVANCED MODEL RAILROADING**

#### **MULTIPLE TRAIN OPERATION**

Operating with Insulated Track Blocks—Preserving Reversing with Insulated Blocks—Separate Insulated Loops—Three Two-Train Layouts—A complete Block System

Page 16  
17  
18  
19

#### **TWO-LEVEL LAYOUTS**

How to Install No. 110 and No. 111 Trestle Sets—Typical Layouts Using Trestles—A 4' x 8' Layout with Wiring Diagram

Page 20  
21

#### **YOUR POWER SUPPLY**

Alternating and Direct Current—What a Transformer Does—What Causes Voltage Drop—Using Auxiliary Lockons—Circuits with Common Ground—Transformer Rating—How to Estimate Available Power—How to Estimate Power Requirements—How to Connect Transformers in "Parallel"—How a Circuit Breaker Works—No. 91 Circuit Breaker

Page 21  
22  
23  
24

#### **HOW TO BUILD A MODEL RAILROAD**

Planning your Layout—Typical Layouts in "0" and "027"—"Super-0" Layouts—Layouts for Two 4' x 8' Boards—Landscaping Techniques

Page 24  
25  
26

#### **HOW TO TAKE CARE OF LIONEL EQUIPMENT**

No. 5159 Maintenance Kit—Cleaning Your Equipment—Lubricating Lionel Trains—Where Not to Lubricate—Where to Use Oil or Lubricant—Lubricating Car Trucks—How to Clean Motors—Motor Trouble Shooting—Lamp Replacement Chart

Page 27  
28

**Check Your Equipment**

By the time you read this you have probably already unpacked and examined your Lionel outfit. It's a good idea to save the boxes and the corrugated board packing. They have been carefully designed to protect the equipment and will come in handy for storing or transporting your outfit.

Check and examine the equipment to see that it is in good condition and that nothing has been broken or damaged in shipment. Spin all the car wheels to see that they turn freely. Put a very small dab of Lionel lubricant on the ends of the axles.

If your locomotive is one of those where the motor can be seen from the side (See sketch on page 27), you should lubricate the ends of the armature shaft before you run the locomotive. Your outfit may have been stored on the dealer's shelves for several months and the lubricant put on in the factory may have been absorbed by the packing. Those Lionel locomotives where the motor is concealed are lubricated from an internal lubricant reservoir or oil wick which do not require any attention for a long time.

**Assemble the Track**

After you have examined your equipment, the next step is to assemble the track. While many model railroaders eventually build a permanent railroad on a train board or table, Lionel track and all other equipment is designed so that it can be assembled and operated right on the floor. If you are like most beginners in the model railroading hobby you will be too impatient to run your train to wait for a train table—at least at first. So we will reserve the discussion of train tables to a later chapter and start by telling you how to assemble the very simplest kind of a layout which you can make with your train outfit.

Most Lionel train outfits include enough curved and straight track to make a simple oval. If you want to make a more complicated layout you will have to buy more track, switches and crossings. Many additional types of layouts are illustrated further on in this instruction booklet.

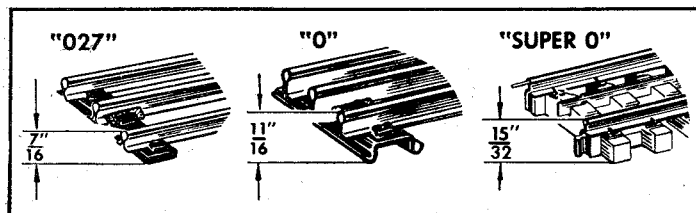

**Various Kinds of Track**

Lionel makes three kinds of track: "0", "027" and "Super-0." — If you have the "Super-0" track see page 2. If you have either "0" or "027" simply push the pins of one track section tightly into the rail openings of the next section. The track should fit together tightly for good electrical contact. If you have occasion to remove or replace the pins make sure they fit tightly.

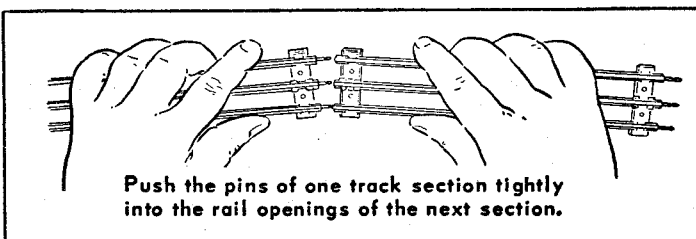

**Uncoupling Tracks**

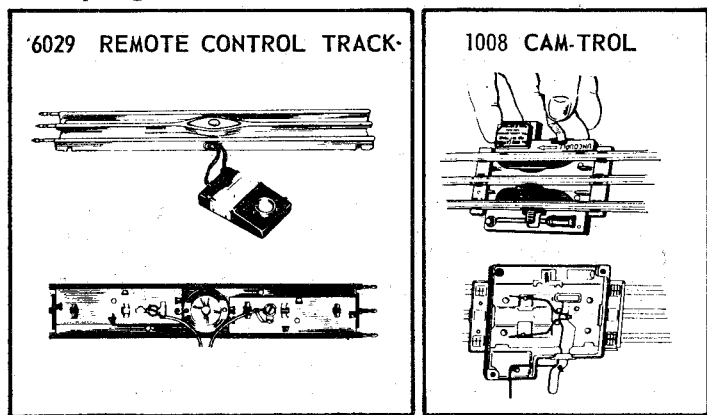

**Attach the Lockon to Track**

After track is assembled, attach a lockon to one of the straight track sections. Lockons are used for connecting wires from the track to the transformer. One CTC Lockon is supplied with each outfit. To dress up your outfit you can

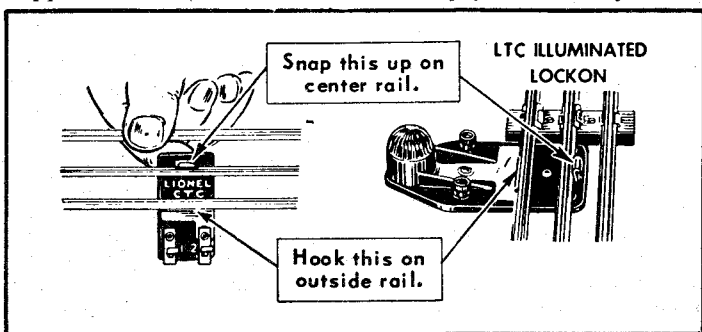

use LTC Illuminated Lockons available at your dealer.

Insulated connecting wires, or leads, are supplied coiled for convenience. You can straighten them out if you like. Before making connections remove the insulating covering.

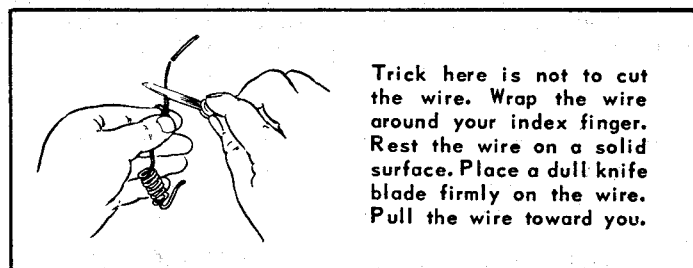

**Connect Lockon to Transformer**

The two lockon clips are now connected to a pair of transformer binding posts. See next page for the correct posts.

Push the springy upper half of the clip down until the metal loop in the lower part projects through the slot in the top. Insert the bare wire end through the loop and release the clip. Repeat with the other clip. Connect the other ends of the wires to transformer. Wrap the bare end of the wire around the post clockwise. Then the wire will not slip out as you tighten the thumb nut.

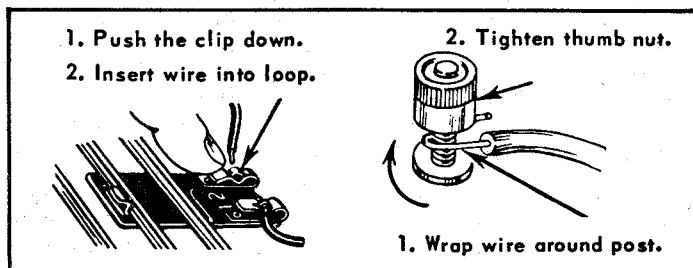

## HOW TO CONNECT TRANSFORMERS TO "0" AND "027" TRACK

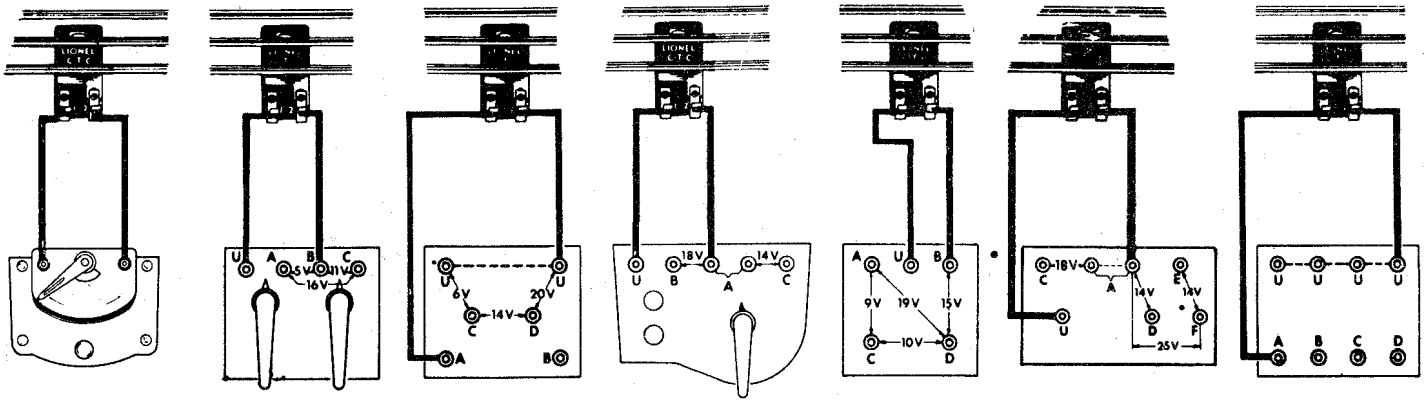

1015 - 1016  
1053 - 1063

These Transformers have two Binding posts. Connect these (as illustrated) to your lockon. The red button on the 1053 and 1063 controls the whistle.

1033 AND 1044  
TOP

If the voltage obtained from the B-U posts is too low for your train, connect wire from lockon to post A instead of B.

KW BACK

The two U posts in this transformer are connected internally so that either U post can be used for "ground."

LW TOP

The two A posts in this transformer are connected internally. Either one can be used for "ground."

RW BACK

If the voltage obtained from the B-U posts is too low for your train, connect wire from lockon to post A instead of B.

TW BACK

Both A posts are connected internally, so that either one of them can be used for "ground" connection.

ZW BACK

All four "ground" U posts in this transformer are connected internally, so that any of them can be used.

In simple layouts the order of the two wires connecting the transformer to the track lockon does not matter because alternating current (A.C.) does not have a definite *polarity* like direct current (D.C.) However, if you are going to use insulated track blocks, or accessories connected to the track but requiring another transformer connection (Such as No. 022 and No. 112 Switches, No. 350 Transfer Table, etc.)

start by wiring the transformer to the track exactly as shown in the illustration above. For transformer connections use the heavier No. 18 gauge brown-covered wire supplied with the transformer.

For further information about Lionel transformers and for other combinations of transformer terminals which can be used, see the section on "Circuits with Common Ground."

### Assembling "Super-O" Track

To assemble "Super-O" track push the track sections together so that the track pins in the running rails enter the rails of the mating section. Note also that the track base itself makes a cylinder-and-socket snap joint with the adjacent sections. The power bus-bars in the center of the track are joined by means of connecting clips which are pushed on from above.

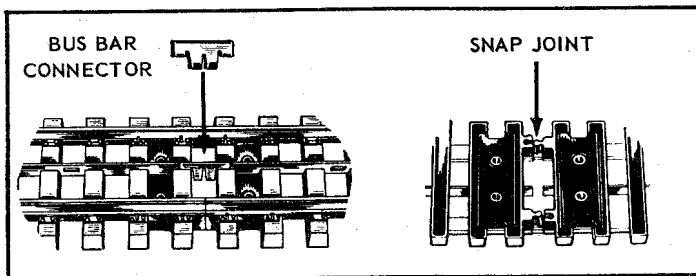

No. 37 uncoupling unit is inserted between any two regular track sections. Being less than 2 inches long it will disturb the symmetry of the layout very little.

"Super-O" track does not use a regular-length remote control track section. Instead, any ordinary straight section can be used to control operating cars by inserting a pair of control blades into the holes in the track base and making the proper electrical connections.

A special straight section of track No. 48 in which the running rails are insulated from each other is supplied with each outfit. You can identify this section by the insulating track pins which are inserted in the ends of one of the rails instead of the regular metal pins and also by the fact that the metal ties on the bottom of the track are cut

through in the middle. This section of track is used to control automatic signals and accessories that you may want to add to your railroad. This track section can also be used as a regular track section. Its insulating pins do not have to be removed.

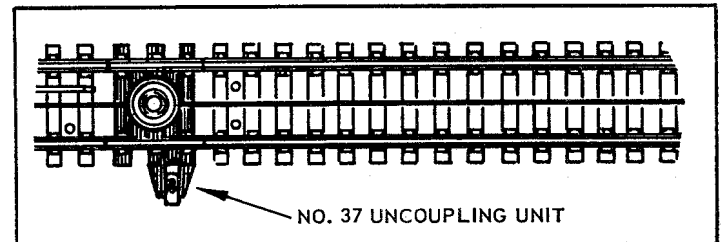

### "Super-O" Track Lockons

Super "O" track has a separate short track section with wiring terminal clips to supply power from the transformer to the track.

One of these No. 43 Power Tracks, which measure  $1\frac{5}{8}$ " long, is supplied with each train set. To make wire connections, push the springy upper half of the clip down until the metal loop on the lower part projects through the slot in the top. Insert the bare wire end through this loop and release the spring clip. Do the same with the other clip making sure the end of the wire is bare of insulation. The other ends of these wires must also be bare and attached to the transformer as on pages 2 and 3. Additional No. 43 Power Tracks may be purchased for use in supplementing distribution of power and also to balance more complicated track systems where a short section of track may be needed.

"Clean and Lubricate Your Equipment"

## "Super-0" Track Electrical Connections

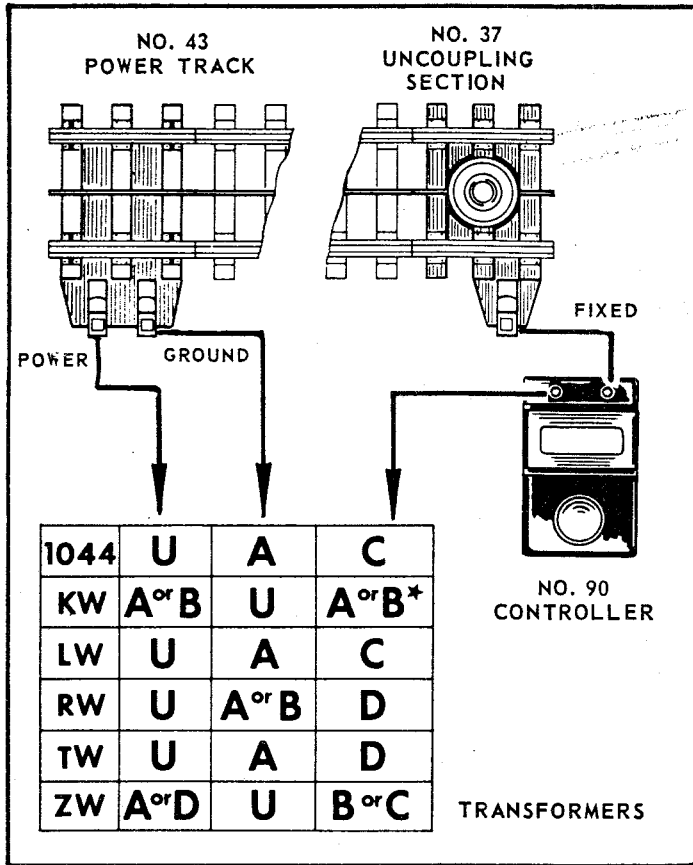

No. 37 uncoupling electromagnet is grounded to the track system through its track pins and receives its power, through a push-button controller, from a transformer post providing "fixed" voltage. Fixed voltage assures snappy uncoupling action regardless of the speed of the train and even if track voltage is off entirely.

The same fixed voltage source is used to supply the remote control blades which are used to control and operate various operating cars. A chart showing the proper connections to various Lionel transformers is shown at left. A complete listing of modern Lionel transformers is on page 2.

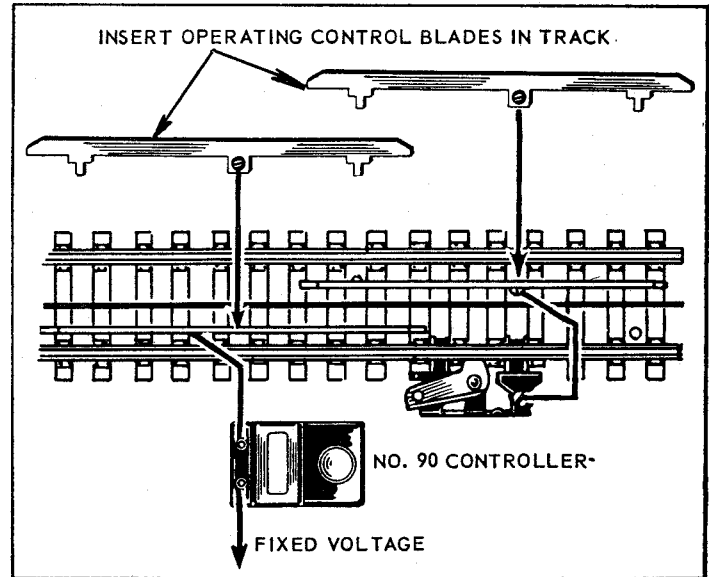

### Place Train on the Track

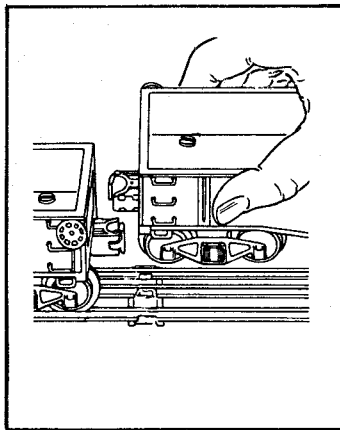

Next, place the train on the track. The order of the cars does not matter except that the caboose is the last car in the train. Cars are coupled together by raising the end of the car and engaging the couplers by hand. Train can be assembled most easily on a straight portion of track. After placing a locomotive or car on the track roll it back and forth to make sure that all the wheels are properly set on the rails. If not they may touch the center rail and cause "short circuit."

### Short Circuits

Most troubles in running an electric train are due to short circuits caused by a derailed wheel touching the center rail. A "short circuit" is a condition where the electric current by-passes the motor or other device it is supposed to operate and flows to the outside rail which is connected directly to the transformer. When a short circuit occurs the train stops, the lights dim or go out altogether; the transformer overheats and, if unprotected, will burn out.

To protect them from overheating and damage due to short circuits most Lionel transformers are equipped with built-in circuit breakers. A few seconds after a short circuit occurs, the circuit breaker opens and cuts off the output of the transformer. After a short time the circuit breaker closes automatically but will reopen almost immediately if the short circuit still exists. Lionel transformers KW and ZW are also equipped with red warning lights which flash on whenever circuit breaker operates.

### Check These Trouble Spots

A derailed car truck. If trouble persists remove all cars and locomotive from the track. Then look for:

Nails, screws, tinsel, etc. across the track. Sometimes a "magnetraction" locomotive will pick up a small iron object and hold it to the track from underneath.

Long wire ends connected to the two lockon clips touching each other.

A bare wire touching two binding posts of a transformer or an accessory piece of equipment.

Broken or displaced insulation between center rail and track tie. This may sometimes be difficult to find. If necessary check each track section separately.

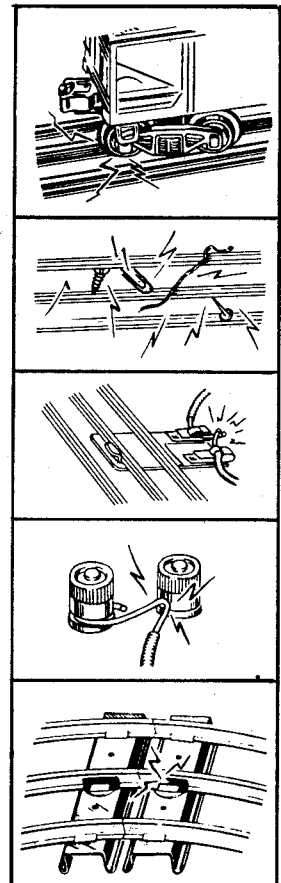

# HOW TO OPERATE THE TRAIN

## Regulating Train Speed

The speed of the train is regulated by moving the voltage control on the transformer panel. The higher the voltage the greater the speed. Most Lionel transformers provide at least two different variable voltage ranges. The lower range is for light trains; the higher range for heavier trains.

## Reversing the Locomotive

Most Lionel locomotives can be stopped and reversed by *remote control*. The reversing mechanism, known as the E-Unit, is inside the locomotive. It is operated by momentary interruptions of current to the locomotive. This can be done by operating the "Direction" control on the transformer or by turning the voltage control to "Off". (Accidental "shorting" of the track, loose connecting wires, missing track pins or dirty track will also cause E-Unit to operate.)

Locomotives are made with Two-Position or Three-Position E-Units. The Two-Position E-unit changes the direction of the locomotive every time the current is interrupted. The sequence is from Forward to Reverse and Forward again.

The Three-Position E-Unit has a neutral position and operates in sequence of Forward, Stop, Reverse, Stop, etc.

## How to Disconnect the Reversing Mechanism

The E-Unit can be disconnected by moving the E-Unit lever to its OFF position. With this mechanism disconnected the locomotive will not reverse its direction after being stopped, but will resume running in the same direction. The E-Unit should be disconnected when you have an automatic station, an operating bridge or insulated track blocks.

To disconnect E-Unit:

1. Start the locomotive going in the desired direction.
2. Stop it with your hand or by turning off track power. (Do not operate the "Direction" control.)
3. Move the E-Unit lever to OFF.

*Note:* If the E-Unit is disconnected while it is in Neutral position, the locomotive will not run at all. Also, because it is operated partly by gravity the E-Unit will not work properly if the locomotive is held on its side or upside down.

## Location of E-Unit Lever

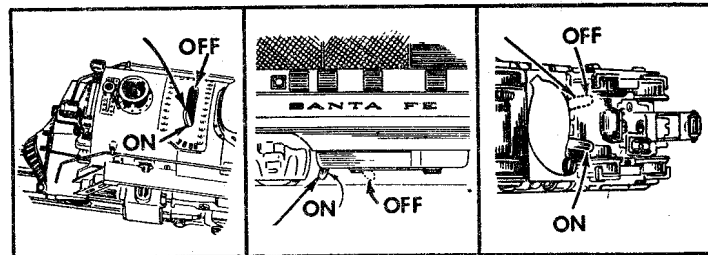

In most steam-type locomotives the E-Unit lever is on top of the boiler, back of the smoke stack or behind the sand dome. In most diesel locomotives the E-Unit lever is underneath the body of the power section.

## "Bumper" Reverse

No. 50 Section Gang Car, No. 60 Trolley Car, No. 52 Fire Fighting Car and No. 69 Track Maintenance Car. All of these units also have a figure or another component that pivots with each change of direction. These do not have a standard 3-position reverse operated by interruptions of track current. Instead, these cars have a mechanism which reverses the motor whenever their buffers strike a track bumper or another car or locomotive.

The "neutral" position on this reversing mechanism is halfway between the two operating positions and can be set either by hand or by striking an obstruction just hard enough to center the reversing mechanism.

## Sounding the Whistle or Horn

Following actual railroading practice most Lionel steam-type trains are equipped with a two-tone whistle while diesel and electric types contain a warning horn. The whistle mechanism is mounted in the locomotive tender. Both the whistle and the horn can be sounded anywhere on the track by operating the whistle controller built into most modern Lionel transformers.

*Note:* Lionel remote control horn and whistle can be used only with *alternating current* having a frequency of more than 40 cycles. When line frequency is less than 40 cycles (some parts of Canada and some communities in the United States use 25-cycle power lines) the whistle and horn will sound continuously and should therefore be disconnected.

## Operation of the Horn

The power for operating the whistle is supplied by the track, but the warning horns use a flashlight cell supplied with the locomotive. In most locomotives the dry cell can be inserted from the bottom, but in some cases the locomotive body must be taken off. When replacing the dry cell be careful to check the size. Some locomotives use size D; others use a smaller size C.

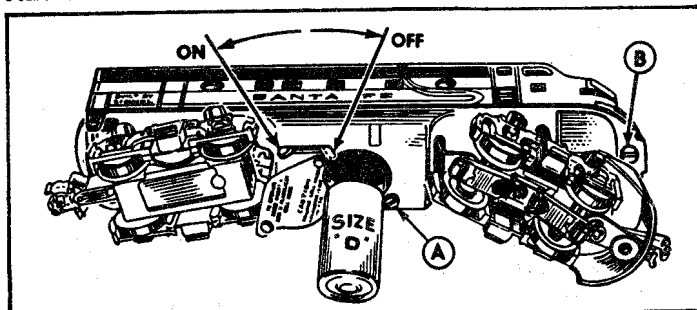

Illustration above shows the location of the dry cell used for the diesel horns. Screw "A" holds the drycell cover. Screw "B" holds the locomotive body.

The horn will sound whenever the car containing it is held upside down because in this position the relay will close through its own weight. Remove the flashlight cell whenever the locomotive is to be transported. To prevent possible damage due to leakage the cell should also be removed when the locomotive is stored away.

## "Magne-Traction" Locomotives

"Magne-Traction" is an exclusive Lionel development whereby magnetic force is supplied to the locomotive wheels by means of powerful Alnico magnets to enable the locomotive to climb grades and to pull heavier loads without slipping on the track. "Super-O" Magne-Traction locomotives can pull a train up a slope provided by Lionel No. 110 Trestle Set (About 1/2 inch per section of track.) However, some of the less expensive "027" locomotives will not pull a complete train up a steep grade and you may find it necessary to operate with a shorter train.

Be careful not to let pins, paper clips, carpet tacks or other loose small iron objects come in contact with the wheels, gears or axles because they may jam the locomotive mechanism. To obtain the benefit of "Magne-Traction" use only steel rails. Magnetism is not effective on aluminum or brass rails.

\* Registered in the United States Patent Office.

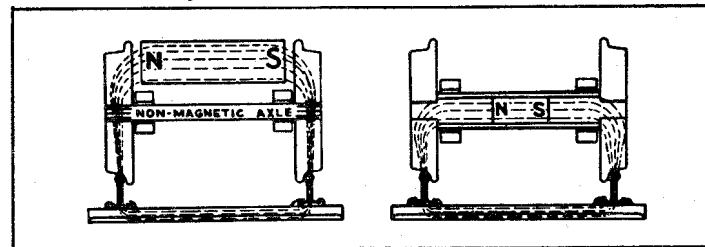

The sketch above illustrates how "Magne-Traction" is achieved in modern Lionel locomotives. On the left the magnet is placed next to the wheels. On the right it is inserted into the axle itself.

"Clean and Lubricate Your Equipment"



## Lionel "Smoke" Locomotives

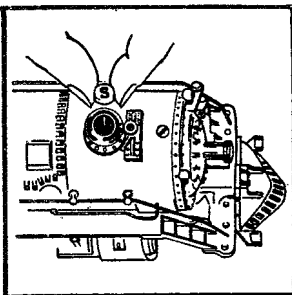

Most Lionel steam-type locomotives are equipped with a smoke generator which produces odorless, realistic "smoke". Drop a smoke pellet into the locomotive stack and turn on the track power. In a few seconds the heater in the smoke generator melts the pellet and smoke rises from the stack. The locomotive will puff only when the wheels are turning.

### Important

Lionel locomotives are equipped with two types of smoke-producing mechanisms.

If the locomotive requires Pellets, use only Lionel No. SP. Any other material may damage the heating element in the smoke generator. Use only one pellet at a time making sure that each is used up before dropping in another. Too many pellets will clog the generator and result in less smoke.

Other Lionel locomotives require No. 909 Smoke Fluid furnished in squeeze bottles. Place four to eight drops in the smoke generator. Make sure that smoke fluid in the locomotive is used up before putting more into the generator. An excess amount will overflow and spill from the locomotive.

Only Lionel No. 909 Smoke Fluid should be used. Other smoke producing compounds may result in damage to the smoke generator.

Both Lionel No. SP Smoke Pellets and No. 909 Smoke Fluid have been rigorously tested and are free from any toxic effects. They are absolutely harmless even if accidentally swallowed by a small child.

### How to Take Care of Smoke Locomotives

After the locomotive has been used for a while it may produce less smoke than it did at first. This may be caused by smoke material clogging up the stack, or the small air opening inside the generator. Clean out the stack, increase the track power slightly and let the locomotive stand in

neutral for a few minutes. This treatment will melt the smoke material. Then lift the locomotive slightly to allow the wheels to turn rapidly. After a few minutes the locomotive will puff as well as ever.

### Coupling and Uncoupling

All standard Lionel cars and tenders are equipped with remote control operating knuckle couplers. Open couplers are closed mechanically, simply by pushing two mating couplers together until their knuckles close and latch. This operation can be done along any straight portion of track provided that at least one of the mating couplers is open.

Most modern Lionel cars and locomotives have "magnetic" couplers with a TRIGGER PLATE or BUTTON which is attracted by the central electromagnet of the control track. To open a "magnetic" coupler move the car so that the truck you wish opened is over the uncoupling electromagnet. Then push the "Uncouple" button.

"Magnetic" Button-operated Couplers can be operated mechanically by means of the No. 1008 "Cam-Trol" uncoupling unit and also by any Remote Control Uncoupling Track Section.

Remote Control Uncoupling Track Sections are available for all types of Lionel track. These are: No. 6019 for "027" track, No. UCS for "0" gauge and No. 37 for Super "0".

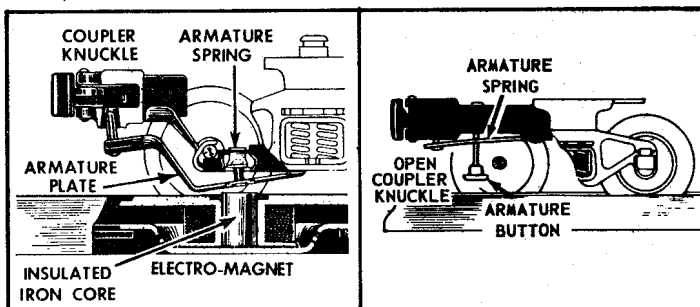

Illustration on the left shows the mechanism of a "trigger plate" coupler. The illustration on the right shows a "button" coupler.

## AUTOMATIC OPERATING CARS

### Cars Using Contact Slide Shoes

The mechanism of most operating cars is powered by an electrical coil, which is connected with one or two sliding shoes located on the bottom of the car trucks. These sliding shoes make contact with the track in a variety of ways: through control rails of UCS or No. 6019 Remote Control Track Sections, through OTC contactors which are clamped to ordinary track, through special contact blades built into the bases of various trackside accessories or through remote control blades of "Super-0" track. Cars which are made to operate on Remote Control Track can also be made to work on a pair of properly spaced and connected OTC contactors. To operate cars of this type, position them so that the slide shoe or shoes ride up on the control rails or blades. Then push the appropriate controller button.

Note: Nos. 6009 and 6029 uncoupling track sections supplied with some lower-priced Lionel train outfits do not have control rails and cannot be used to operate cars of this type. Listed below are some of the most-recently manufactured operating cars using contact slide shoes.

CAR	OPERATED BY
No. 3359 Dump Car No. 3562 Barrel Car No. 3356 Horse Car No. 3656 Cattle Car No. 3424 Brakeman Car	2 OTC Contactors } or 1 OTC Contactor } "Super 1 OTC Contactor } 0" Blades *Cattle Platform Blades *Low Bridge Signal Blades
No. 3662 Milk Car No. 3482 Milk Car No. 3461 Lumber Car No. 3361 Lumber Car No. 3469 Coal Dump Car	{ UCS or No. 6019 Remote Control Track, 2 OTC Contactors, or 2 "Super-0" Operating Blades

Because of the closely-spaced track ties of "Super-0" track, the special contact blades of such equipment as the No. 3656 Cattle Platform, No. 497 Coaling Station and the "low bridge" signal blades of No. 3376 Giraffe Car cannot be fitted into the regular "Super-0" track and must be mounted on No. 38 Accessory Adapter Sections, which are sold in pairs each one-half length of a regular "Super-0" straight section.



No. 38 Sections are 5 3/8" long and must be used in pairs to balance the layout.

### OTC Contactor

OTC contactor is clamped to the track like a lockon and the height of its control rails adjusted to match the height of "0" or "027" track. When the OTC contactor is clamped to the track, its No. 2 clip makes automatic contact with the center rail and No. 1 clip is connected internally to both control rails. The illustration below shows how the OTC control rails may be connected to track power, to fixed voltage or to "ground."

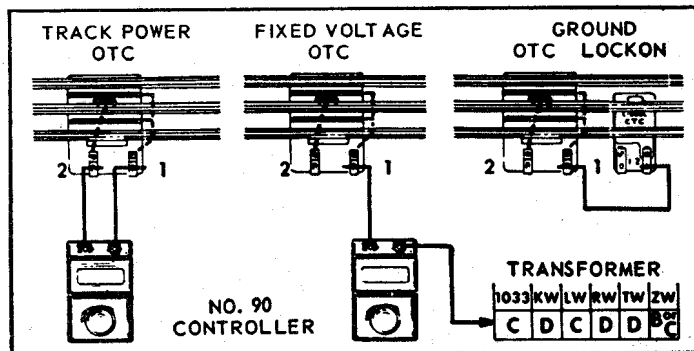

### No. 3376 Operating Giraffe Car

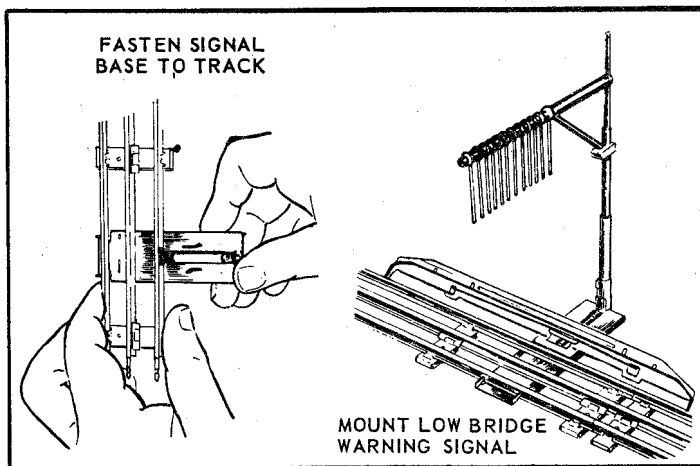

The Giraffe which is being transported in this box car has his head protruding through the roof hatch. When warned by a "low-bridge" signal, the Giraffe drops down to avoid hitting the obstruction. After passing the obstruction the Giraffe rises again.

This action takes place when car passes over a cam plate which is placed along side of a straight section of track (or on the *inside* of a straight and curved section). The illustration above demonstrates the how to install the "low-bridge" signal and cam plate. The car operates efficiently in either direction.

*Note:* The base of the "low-bridge" signal cannot be installed on a regular "Super-O" track section, but must be

mounted on special No. 38 Accessory Adapter Track sections available from your dealer.

### No. 3361 Lumber Car

The dumping mechanism of the 3361 Lumber Car is operated by a cam which raises the unloading frame of the car gradually, in steps, until the logs roll off. The cam rises a step every time that the controller button is pressed. After reaching the highest point, the frame drops back to its normal position. To bring the cam around to the point where it will begin to raise the unloading frame again, the button must be pushed seven times.

No. 3361 Lumber Car is equipped with a pair of slide contact shoes and can be operated either on No. 6019 or Type UCS remote control track section, on a pair of OTC track contactors, or, if "Super-O" track is used, on a pair of No. 36 Operating Blades inserted into any straight track section and connected as shown on page 3.

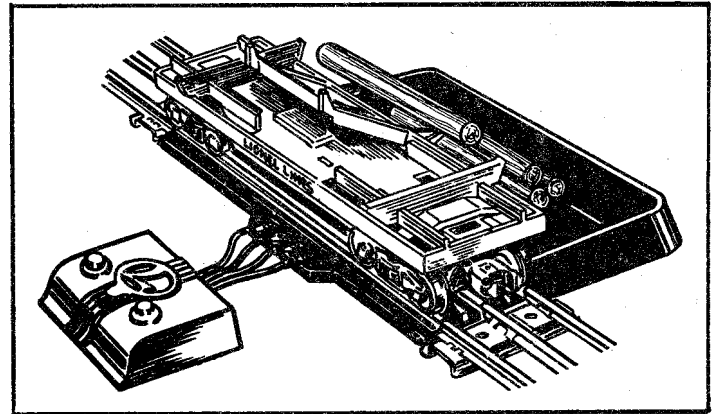

### No. 3927 Track Cleaning Car

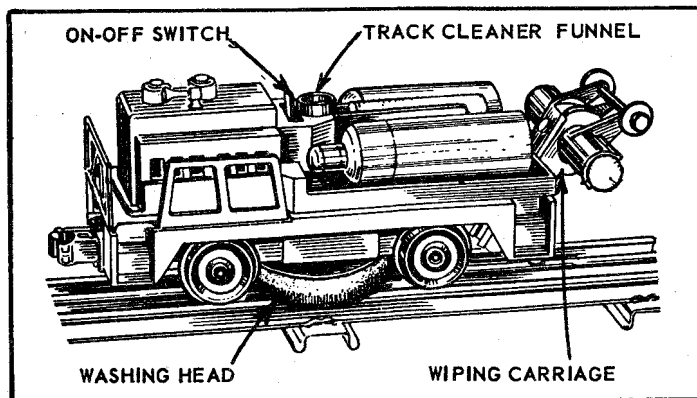

No. 3927 Track Cleaning Car is designed to do a double job of washing and drying the track rails. To wash the rails squirt a small amount of track cleaning fluid from the plastic squeeze tanks supplied with the car into the funnel on top of the car; then switch on the washing head motor. Couple the track cleaning car to a locomotive and let it make several circuits of the track.

To wipe the track dry, pull out the washing head, lower the wiping carriage so that the cotton wiping cylinder rides on the rails and let the car make a few more circuits.

A generous amount of special track cleaning fluid and wiping cylinders are supplied with the car; additional quantities may be purchased from your Lionel dealer.

**Caution:** For washing the rails use only the new non-inflammable, non-toxic Lionel No. 3927-75 "Track-Clean". The large surface of the washing head sponge greatly increases the flammability of any inflammable fluid. For that reason no inflammable cleaner should be used.

### No. 3359 Twin-Bin Dump Car

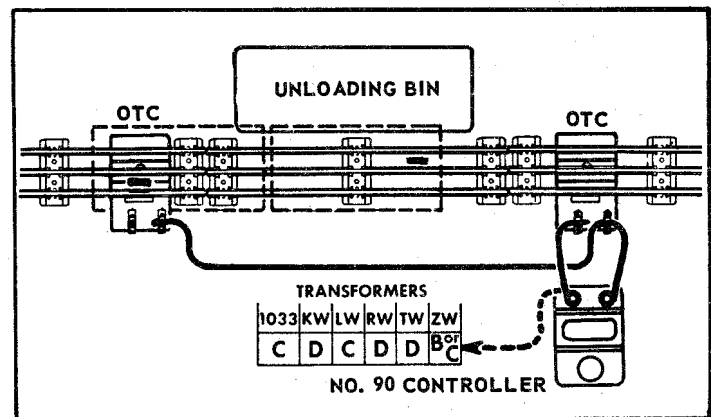

The two dumping sides of this car tilt alternately, rising a notch every time the controller button is pressed. If you are unloading the car into a track-side storage bin, Loader or Coaling Station, you will have to move the car over about one-half of its length after one side has been dumped so that the second side can be dumped into the same bin. For this reason, the regular remote control track sections are too short and 2 OTC contactors are furnished.

The contactors or operating blades should be about 13" apart so that one of the car's sliding contact shoes is on a control rail in both of its operating positions. The contactors are connected together and to No. 90 Controller. If the controller is connected to the two clips of the OTC contactor the car will receive track voltage. For fixed voltage wire the controller to transformer instead of the OTC contactor as shown by dotted line.

To prevent accidental dumping action when cars are uncoupled, there is a lock located in the under-frame of the car.

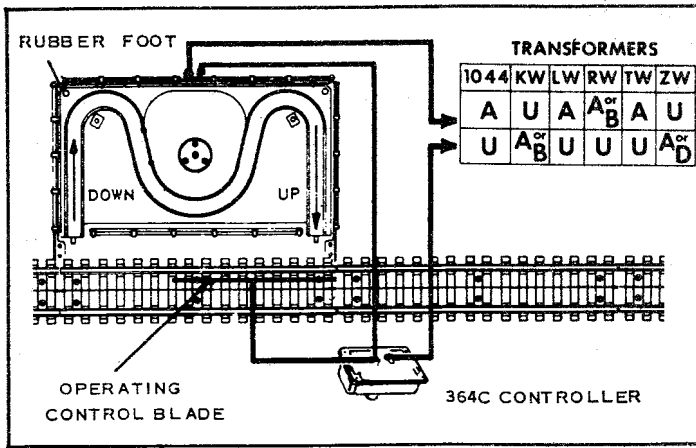

**No. 3356 and 3366 Operating Horse Car and Circus Car**

This car does not use the regular remote control track but is operated either by means of an OTC contactor on "0" or "027" track or by a "Super-0" control blade. Both the corral and the OTC contactor or control blade are then wired through a 364C controller either to the center rail of the track or directly to a fixed voltage post of a transformer. The sketch above shows the "Super-0" track installation.

When the car is aligned in front of the corral and put into operation by means of the 364C controller, the car ramps will drop down to meet the corral and miniature horses will troop out of the car, around the corral enclosure and back into the car. The car will operate only when it is in correct position, with the ramps facing the corral.

The height of the corral platform is adjustable for use with "0" or "027" track by reversing the rubber feet under the platform. "Super-0" track uses "027" adjustment.

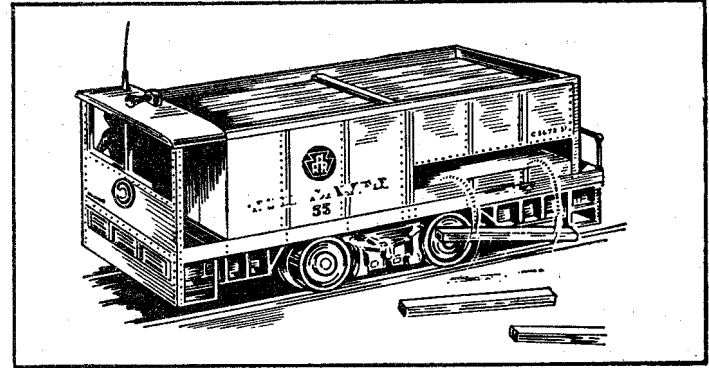

**No. 55 Tie Unloading Car**

No. 55 Tie Unloading Car is equipped with its own motor which enables it to run on the track as an independent track-repair unit. A coupler in the rear enables it to pull another car, which can be used to carry extra track ties, etc. The ties, which are furnished with the car, are loaded into the rear compartment of the car by hand. As the car runs along the track it will eject track ties, one at a time, along the railroad right-of-way. The unloading action is started and stopped by means of a pair of track-side trips, which are clamped to the track, as illustrated below. The lever on the track trip can be used to move it out of the way, if desired.

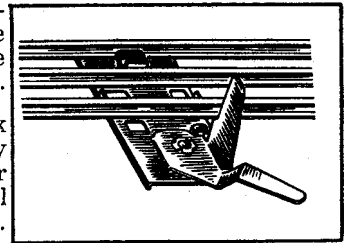

Some of the earlier track trips were made to fit only "027" and "0" track. However those produced later, fit all track including "Super-0" track.

**PART TWO**

**MODEL RAILROAD ACCESSORY EQUIPMENT**

Lionel model railroad accessory equipment depends on the transformer for its operating power and works on voltages ranging from 10 to 14 volts. The higher portion of this range is frequently required when the working parts of an accessory are new, but the voltage can usually be decreased as the mechanism becomes worn in. If an accessory is operated continuously for a long period of time, however, its operating voltage rises as its coil or motor warm up in use.

As explained in the section on "Power Supply" the actual voltages supplied by the transformer posts under operating conditions may differ considerably from the "nominal" voltages marked on the transformer panel. For this reason it is not always possible to give a hard and fast rule for connecting a piece of equipment to a particular pair of transformer terminals. The best practice is to connect it to a pair of transformer binding posts which furnish approximately the required voltage, as indicated in most wiring diagrams. Then, if the accessory does not operate with enough snap, shift to the next higher available voltage. For some accessories of the vibrating type it is best to use variable voltage which can be adjusted precisely to give the best operation.

It is good practice to run any Lionel operating or illuminated accessory at the lowest possible voltage.

In this way you will prevent unnecessary wear of equipment and prolong the life of the lamps. A summary table listing the actual operating voltages required by various Lionel accessories is found on the right.

The number of operating accessories which can be used with your model railroad is limited only by the wattage rating of your transformer as discussed in the section on Power Supply. In most cases, however, since these accessories consume power only when in actual operation, almost any desired number of them can be installed in a layout provided that they are not operated simultaneously.

Illuminated Accessories and Automatic Signals		
71 and 76 Lamp Posts 114 & 118 Newsstands 133 Passenger Station 193 Water Tower 195 Floodlight 394 and 494 Beacons 410 Blinker	12-14 volts	Use fixed voltage slightly lower than specified, to prolong lamp life. Also see page 15.
140 Banjo Signal 145 Gateman 151 Semaphore 153 and 353 Stop Signals 155 Ringing Signal 252 Crossing Gate 445 Switch Tower 450 Signal Bridge	10-14 volts	These accessories receive fixed voltage through No. 145C or No. 153C Contactors. See pages 16 to 19.
154 Highway Signal	9-14 volts	This receives track voltage through 154C contactor.
Track and Operating Accessories		
260 Bumper 1122 Switches	9-14 volts	Track voltage. No wiring required.
*022 and 112 Switches *6019 or UCS Track	10-14 volts	Track voltage (no wiring) or fixed voltage.
*456 Coal Ramp *497 Coaling Station	9-14 volts	Track voltage (Through lock-on) or fixed voltage.
*For usable voltage circuits see page 51.		
128 Newsstand 138 Water Tower 197 Radar Antenna 264 Fork Lift Platform 282 Crane 334 Dispatching Board 342 & 345 Culvert Sta. 350 Transfer Table 352 Icing Station 356 Freight Station 362 Barrel Loader 364 Lumber Loader 397 Coal Loader 415 Diesel Serv. Sta. 464 Saw Mill 3356 Horse Corral	10-14 volts	These accessories operate on voltage within the range of 10-14 volts. Because individual items may vary somewhat you may have to experiment a bit to determine their best operating voltage. Connect to variable voltage posts and adjust for best operation.
253 Block Control	6 V.D.C.	Track voltage through Lockon.
465 Dispatching Sta.	9-14 volts	Batteries and track voltage.

## PARALLEL CONNECTIONS

In the event you have several railroad accessories requiring the same voltage it is advisable to use the same pair of transformer binding posts for all of them, wiring them together in "parallel", as shown below. Two main feeders go to the transformer posts and individual wires go from these feeders to the accessories. In this way unnecessary wiring is eliminated. If your outfit is mounted on a table or platform the main feeders can be stapled to the under side of the table and small holes drilled next to each accessory for the wires leading to the accessory.

The feeders can be made from ordinary lamp cord or thin metal strips. In permanent layouts the wire connections

are frequently soldered together.

Most operating accessories can also be wired in this manner with the various switches and controllers inserted in one of the connecting wires, as shown.

Remember that if two or more 14-volt accessories are wired together in "parallel", they must still be connected to the 14-volt posts on the transformer and not to posts which give the total of the individual voltages required.

In order to guard against possible short circuit in one of the accessories it is a good idea to insert a No. 91 or 92 Circuit Breaker into the power line supplying the bank of accessories, as illustrated below.

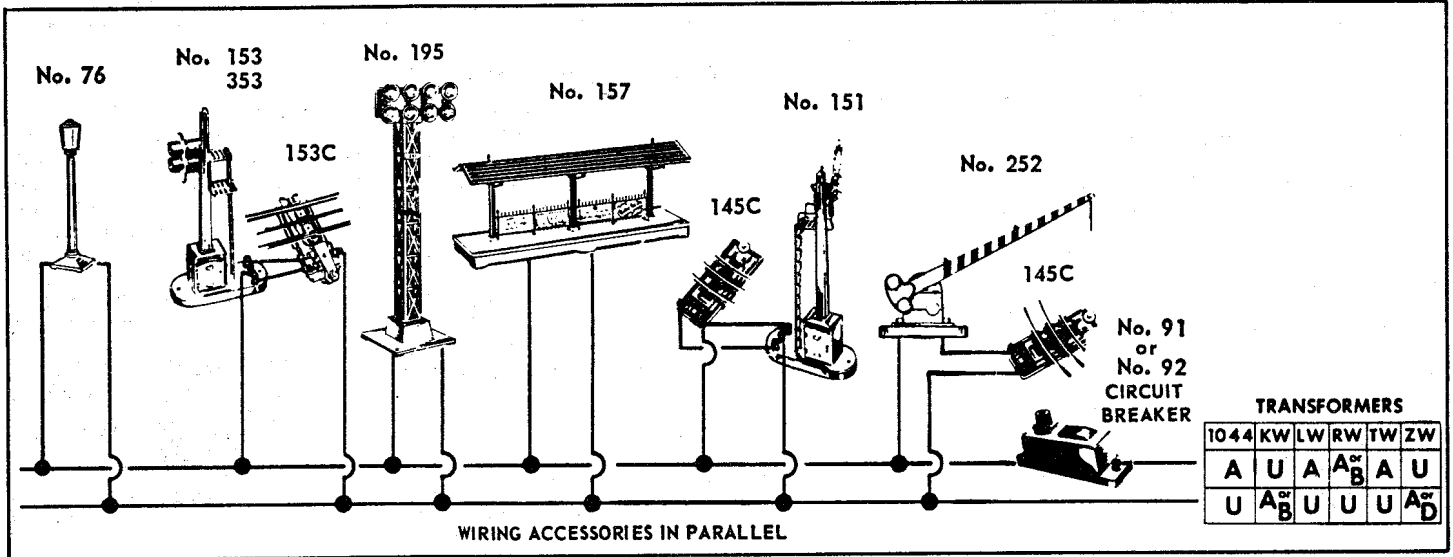

## AUTOMATIC SIGNALING

Model railroad signals and trackside accessories made by Lionel are usually operated automatically by means of "contactors" actuated by a passing train. Contactors 145C and 153C are worked mechanically by the weight of the train. Others are operated electrically by the train wheels making an electrical contact with the contactor surface and in this way completing the electrical circuit.

*Pressure-type contactors are placed underneath the track so that a track tie rests firmly on top of the contactor. If the track is fastened to a platform make sure the track is loose for several sections on either side of the contactor because the track must be free to bend under the weight of the train. An adjustment nut is provided to regulate the weight*

required to operate the contactor. This is done after all wire connections are made and transformer power is on. Stop the train several sections away from the contactor. Turn the adjustment nut either up or down until the signal operates. Then turn the nut back just enough to return the signal to its normal non-operating position. By varying the setting of the adjustment nut the signal can be made to respond either to the weight of the heavy locomotive alone, or to the lightest car.

Pressure contactors can be used equally well with "Super-0" track which has special notched ties to accommodate No. 153C Contactor.

The 145C Contactor, electrically, is a single-pole, single-throw, normally-off switch. The end view of the contactor below shows it with its contacts in their normal, open position.

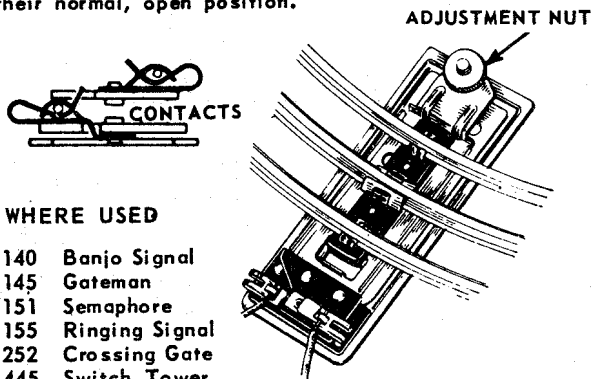

The 153C Contactor, electrically, is a single-pole, double-throw switch. The diagram of the contactor below shows the normal position of its contacts.

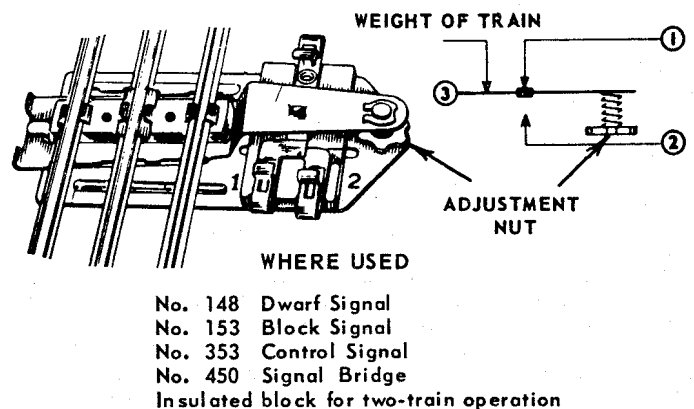

## Using Insulated Control Rails

Another method of operating track-side signals automatically is by connecting the "ground" side of the signal circuit to an insulated outside rail, as illustrated in the following pages. Then, as the train reaches the insulated rail, its wheels bridge over to the opposite outside rail, which is grounded, and complete the electrical circuit causing the signal to operate.

If you use "Super-O" track, one such special track section No. 48 is furnished with each outfit. Curved special sections No. 49 are available from your dealer.

If you use "0" or "027" track you can make your own special control sections by insulating one of the outside rails as illustrated on page 15.

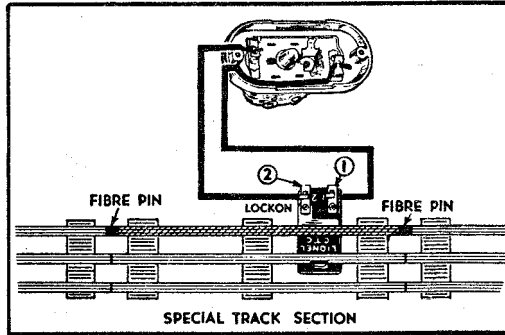

Left: No. 252 Crossing Gate Operated by an Insulated Track Section. No. 140 Banjo Signal, No. 353 Control Signal and No. 155 Ringing Signal Can Be Operated in the Same Way.

Right Bottom: Insulated Track Section Used for Automatic Control of Switches.

Right Top: No. 145 Gateman Operated by Insulated Track Section.

The method used for controlling No. 145 Gateman can be used as well for No. 151 Semaphore and No. 445 Switch Tower. In the case of No. 151 Semaphore the center post is connected to the transformer, the outside post which lights the lamp is connected to No. 2 clip of the lockon outside the insulated track and the post operating the semaphore arm to No. 2 clip of the lockon on the insulated track.

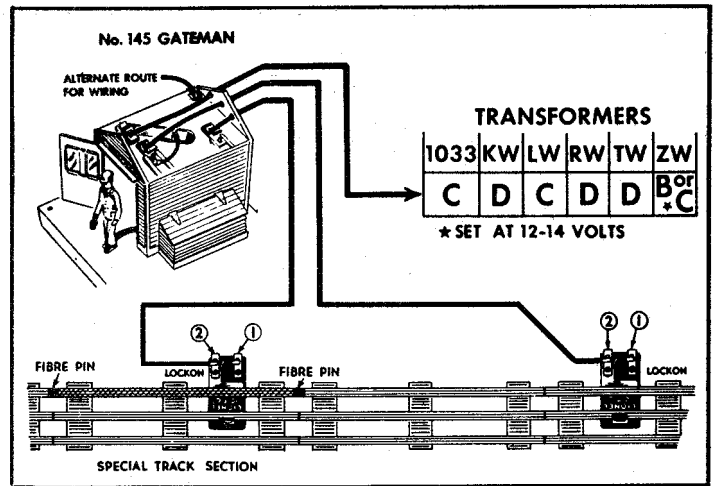

To operate the Switch Tower its No. 2 clip is connected to the transformer, No. 3 clip to lockon outside the insulated track and No. 1 clip to the lockon on the insulated track.

Although No. 022 Switch Is Illustrated Other Automatic Switches Such As No. 1122 and No. 112 Can Be Controlled in the Same Way.

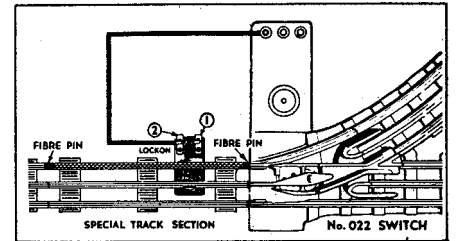

Of course, if you wish the train to operate several of these accessories simultaneously all of them can be connected to the same insulated track section.

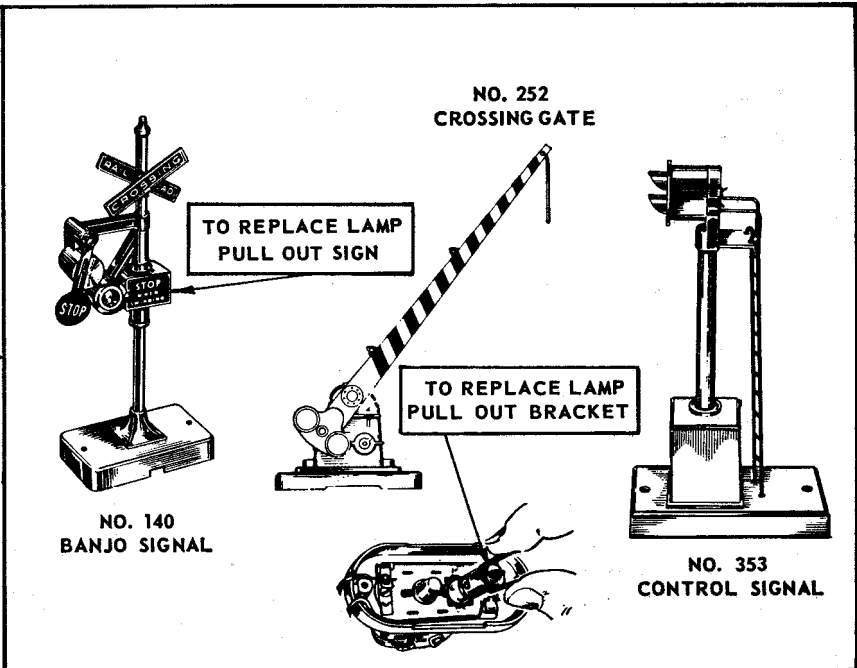
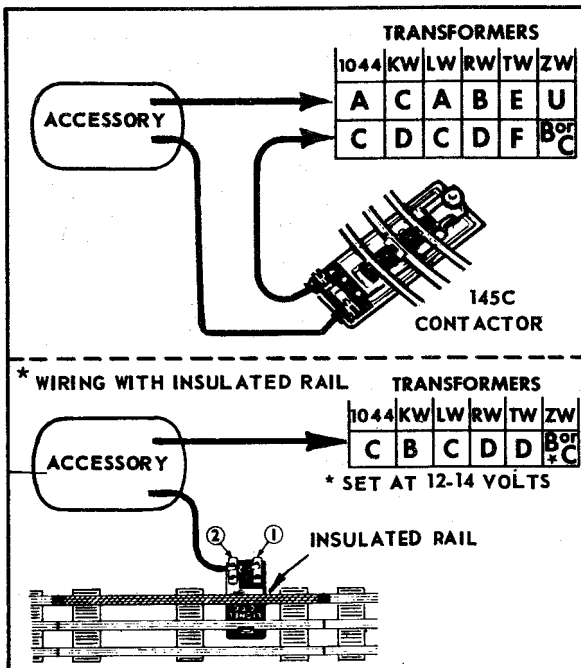

## Operation of Automatic Accessories

The two crossing signals and the crossing gate illustrated above are all connected in the same way. In most temporary layouts the installation using a 145C contactor, which is furnished with these accessories, is easiest to make. The 145C contactor is installed under the track and adjusted as explained on page 8. As the train passes over the contactor the signal or the crossing gate goes into action and continues to operate until the train has passed.

In permanent layouts where the track is fastened down to

a board or platform it is frequently desirable to control these accessories by means of insulated track rails which can be made from regular "0" and "027" track sections as shown on page 18 or by using No. 48 Insulated Track Sections supplied with "Super-O" outfits. Insulated rail method requires no adjustment, but care must be taken to connect the transformer to the track as shown on pages 2 and 3.

If desired, two or more accessories can be connected to the same 145C contactor or to the same insulated rail so that they operate simultaneously as the train passes by.

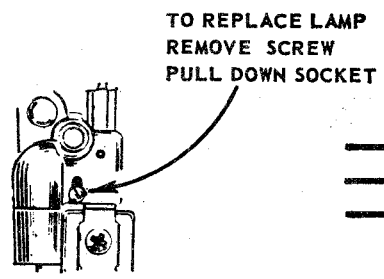
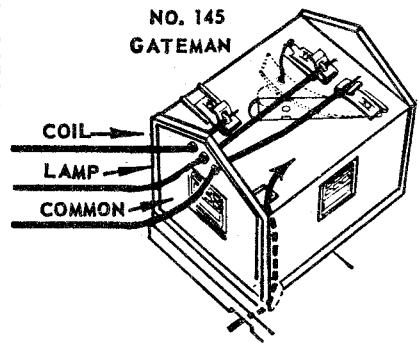
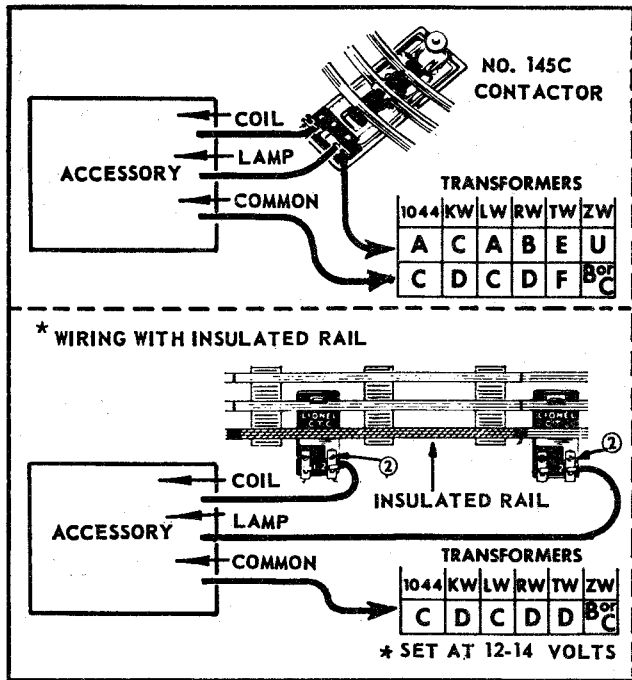

The three automatic accessories shown on this page all operate in the same manner and are connected in the same way. Each of these accessories has three separate terminals: one for its steadily illuminated lamp, one for the coil which operates the mechanism; the third for a common "ground".

When operated by means of the 145C contactor, the accessories must be connected as shown at top left. When connected in this way, the lamp is on all the time, but the mechanism operates only as train passes over the contactor.

In permanent layouts, where the track is fastened down to a platform, many model railroaders prefer to control automatic accessories by means of an insulated track rail instead of the pressure-type contactor. To operate these accessories in this manner the wiring must be inverted, as shown at bottom left, so that the "common" wire from the accessory is connected to the fixed voltage post of the transformer, the "lamp" wire connected to the outside rail of the track and the "coil" wire connected to the insulated rail.

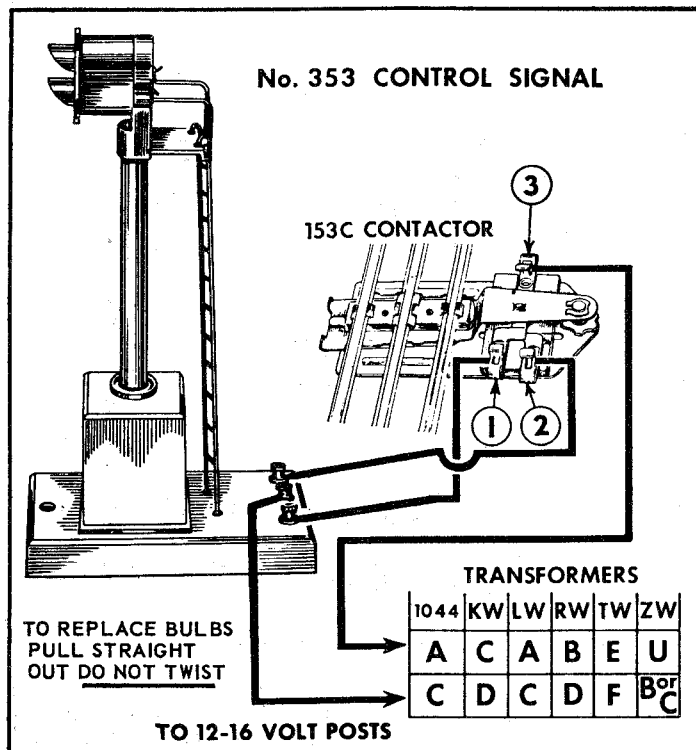

**OPERATION:** Normally current runs from contactor clip 3 to clip 1 illuminating the green light. When contactor is depressed current runs from clip 3 to clip 2, illuminating red light. For alternate hook-up to No. 022 Switches see page 17. For connection to insulated blocks used in two-train operation see page 39.

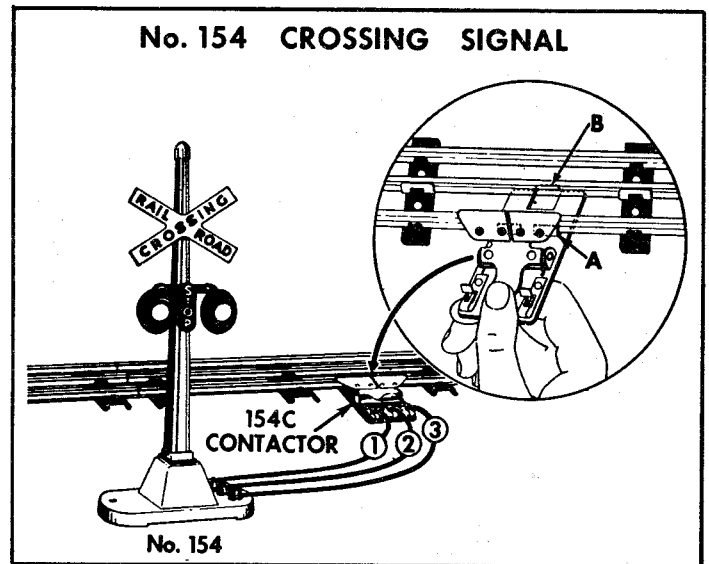

**INSTALLATION:** No. 154 Crossing Signal is connected directly to the track by means of the No. 154C contactor. Attach the contactor to the track by pressing down the spring lever to raise the contact plate, as shown in the inset above; then place contactor under the track with clip "A" gripping the flange of the outside rail, snap spring clip "B" over the center rail, and release the spring lever. With "Super-O" track use special track section No. 38.

**OPERATION:** As the wheels of the train roll over the contactor surface, the red warning lights of the Crossing Signal will blink alternately. Keep the contacting surfaces of the contactor clean and be careful not to disturb the insulating paper on the inside surface of the plates which touch the rail.

## No. 148 Dwarf Signals

Dwarf signals are generally used at interlockings to direct trains in slow-speed areas, such as yards, sidings and terminals and also as "back-up" signals for trains going the wrong way on main lines. Lionel No. 148 Dwarf Signal is sold with a No. 148-100 manual controller which can be connected as shown to interlock the signal with an insulated block or siding so that the operator can control both simultaneously.

For automatic operation the Dwarf Signal can be controlled either by means of a No. 153C pressure-type contactor, as illustrated on page 11, or even by a pair of insulated rails, as shown on page 9, top right. If additional indication is wanted for position of automatic switches No. 148 Signal can be wired directly to the three switch box posts, as shown on page 17.

In the illustration at right the top diagram shows how a No. 148 Dwarf Signal is interlocked with an insulated track block so that the signal will indicate red when the block is "dead," and green when the block is "live." In the bottom diagram the signal is wired simply to show either red or green but not to control the train.

For club use, or where there are several operators, or dispatchers, it is possible to set up a series of blocks which require agreement of two operators to move the train from one block to the next.

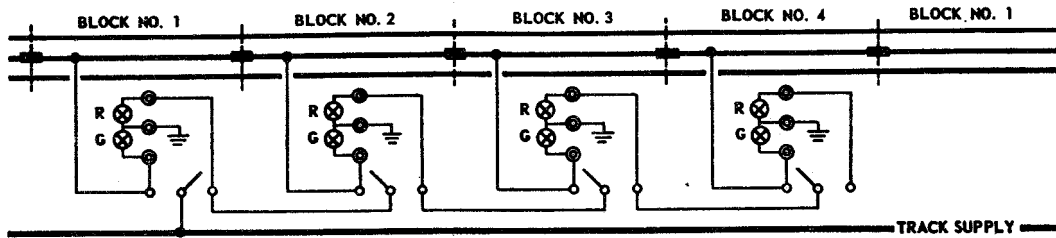
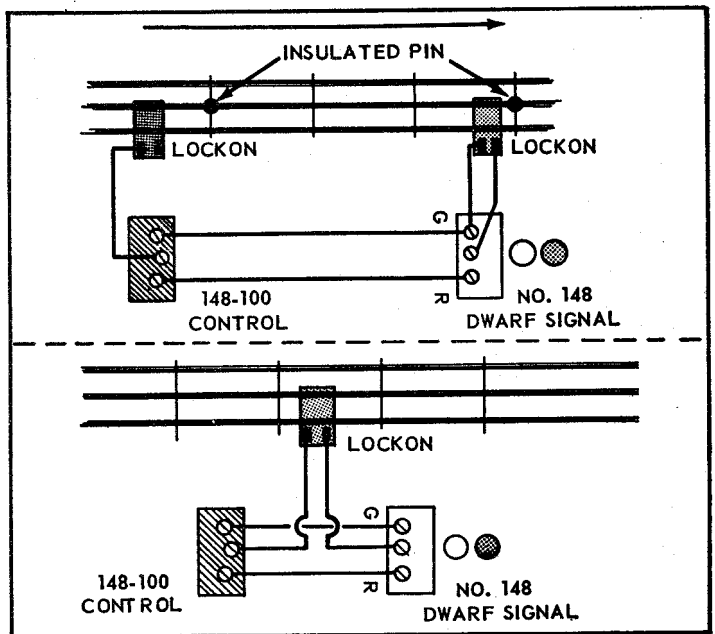

A block system interlocked with No. 148 Dwarf Signals and No. 148-100 manual controllers. Dispatcher in each block can switch power either into his own or into following block. However, dispatcher in the next block can refuse entrance.

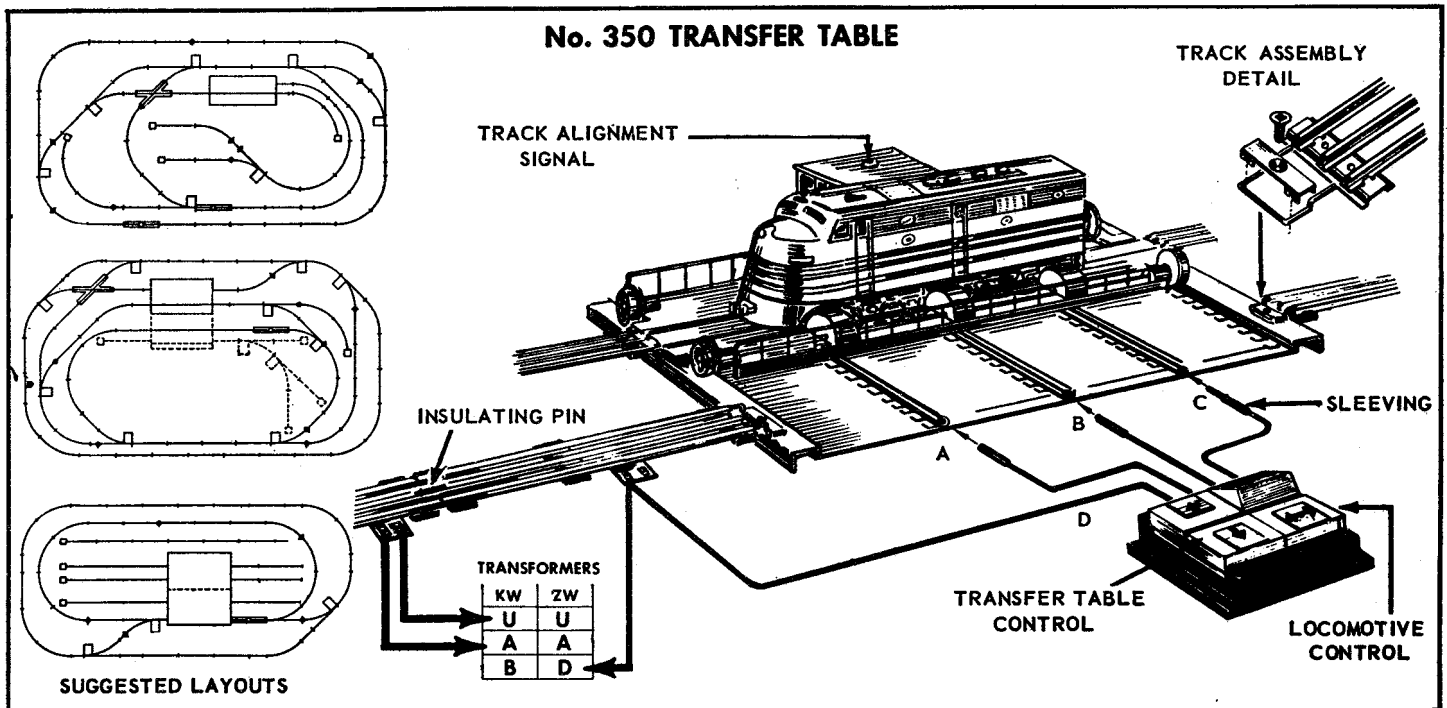

Transfer Tables are used in modern engine yards and terminals to transfer diesel and electric locomotives and other rolling stock to parallel lines of track. No. 350 Transfer Table is designed to service two parallel tracks about 5 $\frac{3}{4}$  inches apart, but additional track beds can be added to extend the travel to four tracks or more.

For easiest control about two track sections adjoining the table should be insulated from the rest of the layout

and wired to the same voltage as the table itself. The illustration above shows one of the approaches wired in this way. A locomotive entering the insulated approach track will now stop until the transfer table rails are aligned with it exactly as shown by light in the control shack. Pushing the "locomotive" button will then energize the approach track and the table track simultaneously. No. 350 Transfer Table is provided with adjustments for all Lionel track.

### No. 264 OPERATING FORKLIFT PLATFORM

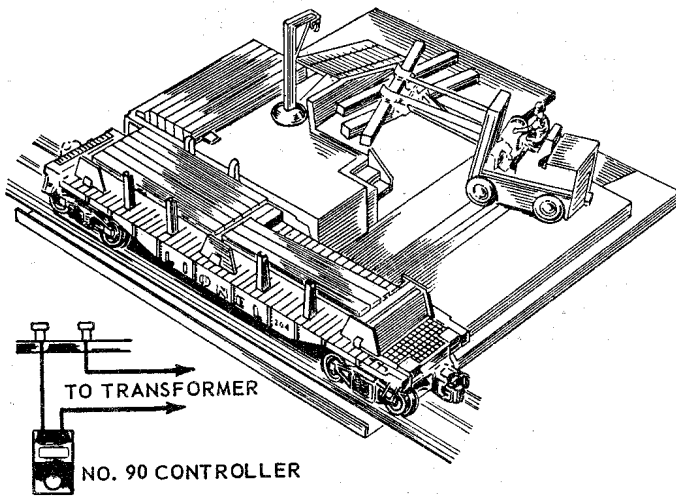

No. 264 Forklift Platform is sold with a special No. 6264 Flat Car carrying a load of timbers. To unload the car the stakes on the side of the car facing the platform must be removed and the car lined up with the platform so that one side of it is centered with the guiding slot for the forklift truck. Each time the controller button is pressed the forklift truck will move to the car, take up a timber and deliver it to the rear of the platform. After unloading one side move the car over so that the other side is in unloading position.

The operating range of the platform is between 10 and 14 volts and it can be connected either to variable voltage source or to any pair of transformer terminals which furnish approximately this voltage.

### No. 464 LUMBER MILL

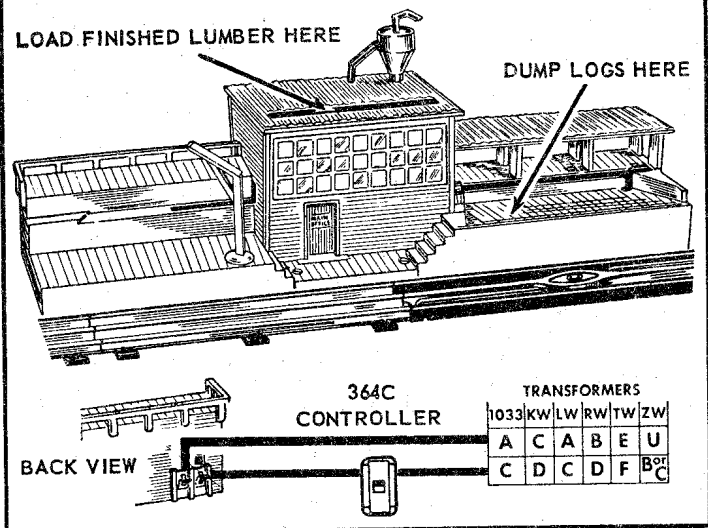

No. 464 Lumber Mill can be installed along any straight stretch of track. A remote control track section should be located in front of the accessory so that a lumber car can dump its load of logs onto the receiving platform at the right end of the mill. When the mill is put in operation by means of its controller, a conveyor belt carries the logs into the mill where they are apparently converted into dressed lumber which emerges at the other side of the mill.

Actually the finished lumber is placed ahead of time into the mill through a slot in its roof and the logs are removed by raising the overhead door in back of the building. The mill operates best at low voltage. Excessively high voltage may cause the lumber to jam in the mill.

### No. 128 ANIMATED NEWSSTAND

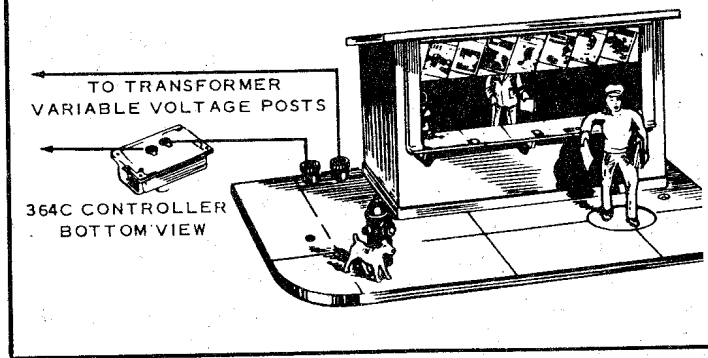

No. 128 Animated Newsstand can be located anywhere on your layout. It is most effective, however, where it will enhance the action of a bustling passenger terminal. The newsstand will operate on A.C. only.

If desired, action may be automatically controlled through a 145C pressure contactor by the weight of a train arriving at and leaving a station. The 145C contactor is available from your Lionel Dealer.

Note: Do not attempt to move the figures by hand or you may disturb their driving mechanism. If this happens, the lantern will light and the mechanism will hum, but the figures will not move. To correct see "Service Information."

The electrical connections for the newsstand are shown above. The 364C controller is connected into one of the lines, and the lines are connected to a pair of transformer posts supplying variable voltage. Apply power and adjust the voltage for best operation, which is usually 11 to 13 volts. Excessive voltage will cause the newsstand to buzz.

### No. 334 DISPATCHING BOARD

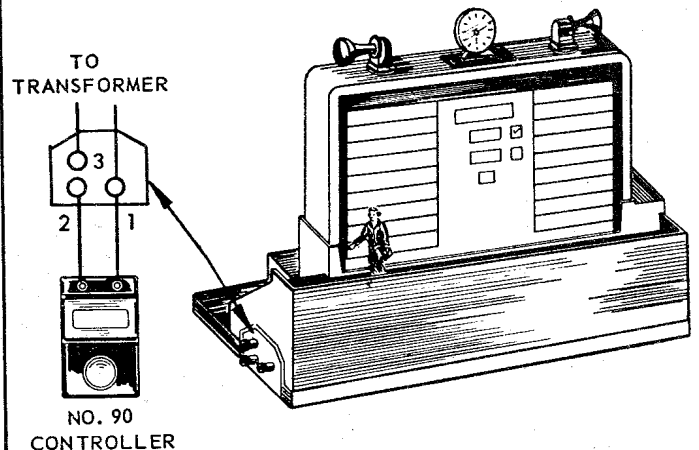

No. 334 Dispatching Board is a good piece of equipment for a passenger railroad terminal, having a ticket office on one side and a huge illuminated dispatching board on the other. Its operating voltage is 10-14 volts a.c. and it is connected to a transformer through a No. 90 controller as illustrated above. When the controller button is pressed the attendant hurries across the catwalk in front of the board and the information on the board changes automatically. The button has to be pressed for an instant only. Once the action is started it will continue automatically until the attendant returns to his post. Additional train information can be chalked in on the special "black-board" surface of the dispatching board.



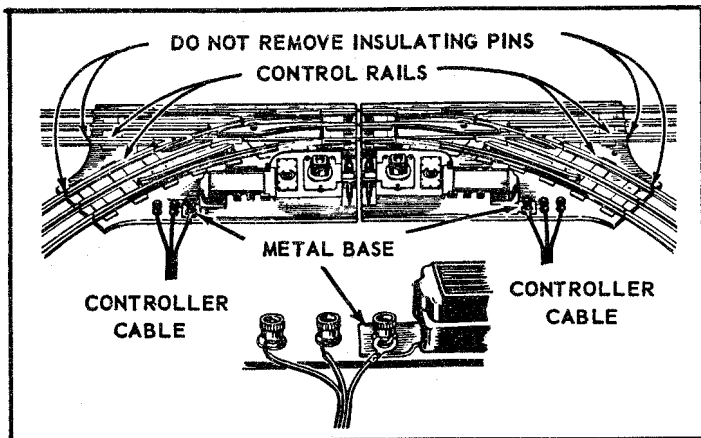

### No. 112 Switches for "027" Track

No. 112 Switches matching "027" track are installed into the track as any ordinary straight and curved sections with each switch replacing one straight and one curved section. No. 112 Switches have no provision for supplying them with fixed voltage but draw their power from the track.

Like No. 022 Switches, 112 Switches are equipped with a non-derailing device which automatically throws the swivel rails to the correct position to accommodate an approaching train. These switches are controlled by double controllers which are connected to the switch boxes by 3-wire cables. Connect the wires in order making sure the wire with the lug goes to the post with metal base.

Switches sold singly, instead of in pairs, are provided with single controllers, somewhat similar to those supplied with 022 switches. In connecting them to the switches make sure that the center wire of the cable is connected to the post with the metal base.

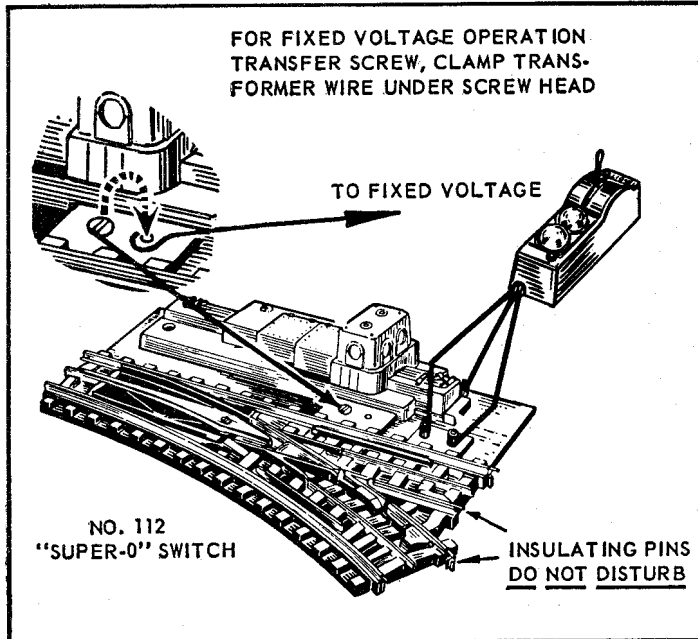

### "Super-0" Switches

To match the "Super-0" track Lionel has produced both No. 112 electrically-operated automatic switches and No. 142 manual switches. No. 112 Switches are similar electrically to the No. 022 switches used for "0" track and have identical safety and fixed voltage features.

As delivered from the factory No. 112 switches are set for normal track-voltage operation. To convert them to fixed-voltage operation, the contact screw on the surface

## INSTALLATION OF No. 022 SWITCHES

DO NOT REMOVE INSULATING PIN FROM CONTROL RAILS

GREEN  
RED

TRANSFORMERS				
KW	LW	RW	TW	ZW
D or B	B	D	C	B or C
A	U	U	U	A or D
U	A	B	B or A	U

\*If voltage obtained from D post of KW transformer is too high, add an adjustable 10-ohm 25-watt resistor

DO NOT REMOVE INSULATING PIN FROM CONTROL RAILS

GREEN  
RED

LOCKON

DO NOT REMOVE FIBRE PINS IN NON-DERAILING CONTROL RAILS

TRANSFORMERS		
R	V&Z	A&Q
E	A or B	C
C or F	C or D	U
B	U	A

167 CONTROLLER

BE SURE PLUG FITS OVER CONTACT PIN INSIDE SWITCH BOX

WHEN NOT USING FIXED VOLTAGE REMOVE PLUG FROM SOCKET

Use of Fixed Voltage Plugs is optional. When they are not used the switch gets power directly from the track.

Keep the non-derailing control rails clean. Do not disturb the fibre pins in the ends of these rails.

When switches are set for train to go along main line the green lights should shine along the straight-away.

of the switch base must be transferred to the hole marked "Fixed Voltage," and a wire leading to a suitable fixed voltage post of the transformer must be connected under the screw head. The correct transformer posts are indicated on page 13 showing the installation of No. 022 switches.

Because "Super-0" switches have 30° turn-outs and take up only one-twelfth of a circle they can be used to make crossovers between parallel lines of track only 4 7/8 inches on centers and also to build closely spaced "ladders" for compact freight and storage yards.

"Super-0" switches may be mated with either "0" or "027" track layouts through the use of either 022-500 or 1122-500 Adapter Sets, illustrated on page 16. The same sets may be used to adapt 022 and 1122 switches to "Super-0" layouts. This provision make it possible to convert to "Super-0" track gradually and economically, saving the cost of buying new "Super-0" switches.

### Manually-Operated Switches

In addition to the automatic electrically operated switches Lionel makes inexpensive manually-operated switches for all types of track. No. 1022 Switches mate with "027" track, while No. 142 is designed for "Super-0" track. A special feature common to both No. 1022 and No. 142 switches is a built-in contact device which automatically disconnects power from either of the two branches of the switch, depending on the position of the swivel rail. By insulating the approaches to the two branches it is therefore possible to construct safety blocks which will automatically stop a train running into a switch which is set against it.

As in real railroading manually-operated switches are particularly useful and economical for infrequently-used sidings, storage yards, and industrial branch lines.

### Special Uses of Non-Derailing Mechanism

The automatic non-derailing mechanism of No. 022 and No. 112 switches can be used for several interesting applications. One of them is shown below. If the outside posts of the switches are connected by wires the train will alternate automatically between tracks "A" and "B."

The operation is this: Train leaving track "A" operates the non-derailing mechanism in the "Exit" switch and at the same time throws the "Entry" switch to position which allows the train to enter track "B". Leaving track "B" the train again throws both switches, but this time in the opposite direction, so that it returns to track "A".

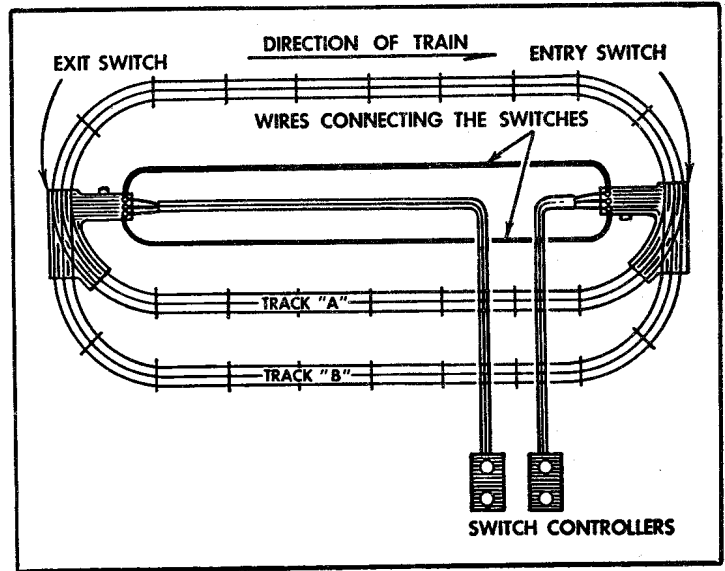

### Controlling Signals with Non-Derailing Mechanism

If a block signal or a semaphore are wired to the switch as shown below they will indicate green "go ahead" when the switch is set for the train to move along the main line and red "stop" when the switch is set for the train to turn into a siding. No. 145 Gateman can also be operated in this way.

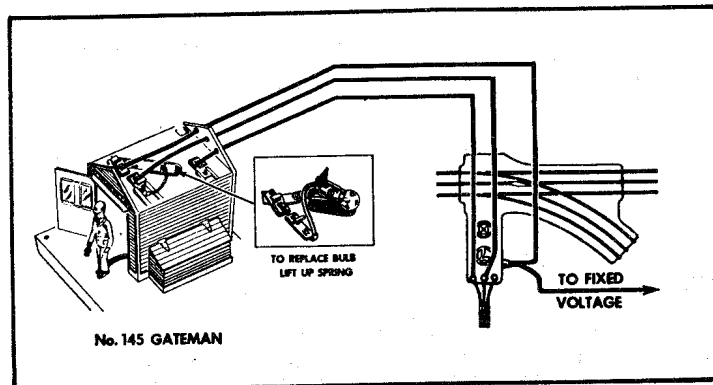
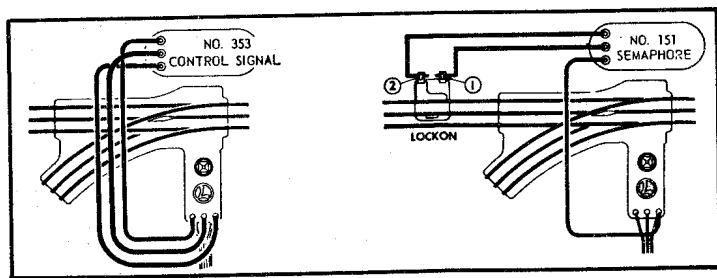

### Track Crossings

Lionel's 90° and 45° track crossings (which are made for both "0" and "027" track) make possible many unusual layouts that cannot be achieved with switches alone. Crossings do not require any special electrical connections and are inserted into the layout as any ordinary track sections. For "Super-0," 90° and 30-60° crossings are available.

The length of a crossing, however, is not the same as that of a straight piece of track but is designed so that crossings can be used in conjunction with switches to form track "wyes", and "figure 8's", several forms of which are shown below.

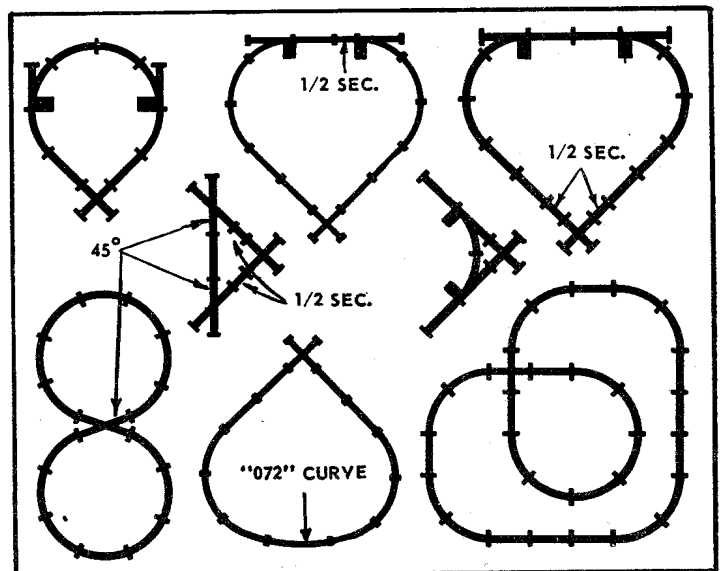



## WORKING WITH LIONEL TRACK

Lionel track is made in three different gauges the regular "0" track, the lighter "027" track and "Super-0" track. Although the track "gauge"—the distance between the outside rails—is the same for all three kinds of track, they differ in the height, shape and diameter of the rails and in the diameter of a track circle. In addition, a wide radius "072" track which is no longer manufactured but

may be found in stores, is very useful in constructing wide, sweeping curves.

In addition to the regular track Lionel makes curved and straight "half-sections" in all types of track which are useful for many kinds of layouts. If the half-sections are not available, or if your layout needs special lengths, it is possible to cut the regular track to the desired lengths. Clamp a track section in a vise using padding to protect the rails from being crushed and cut the rails with a jeweler's saw or a fine-toothed hack saw. Smooth the cut edges with a fine file.

"Super-0" track can be cut in the same way but the cut pieces will not have the interlock feature which helps to align the "Super-0" track bases. Lionel track is somewhat flexible so that it is possible to construct layouts which are not strictly symmetrical. However, be careful not to distort the layouts too much or you may cause the train to derail.

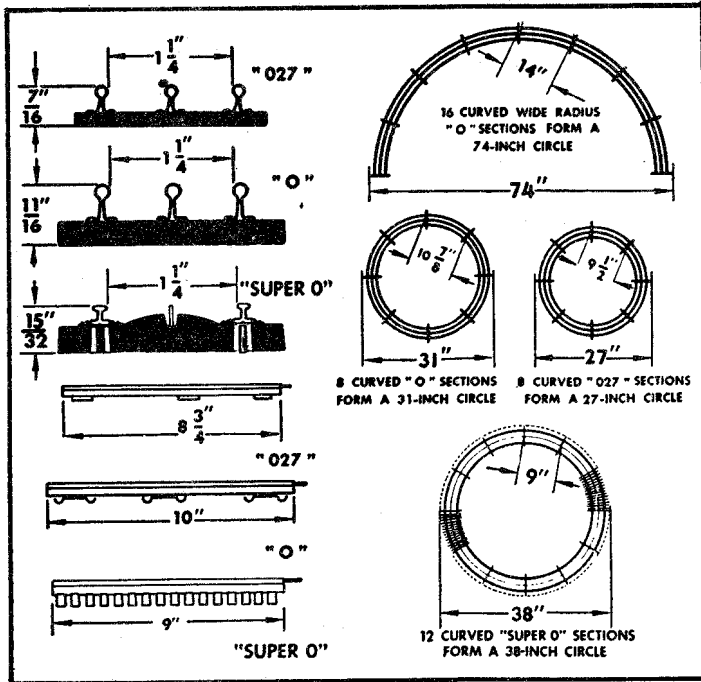
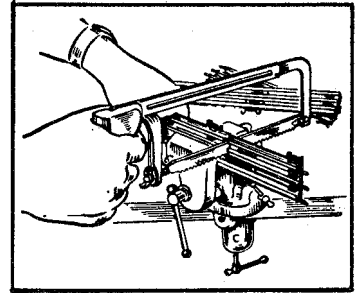

### How to Mount Track on a Platform

If you mount your track on a plywood board or platform your train operation will be smoother and your track will last longer. For fastening track to platform use one No. 3 x 1/2" round head wood screw to each section of "O" track; "027" track requires No. 3 x 3/8" screws. Don't screw down the track tightly or you may distort the track ties causing a "wavy" track. Track should not be clamped down but fastened only enough to keep it from shifting its position. A sheet of "Celotex" or similar material may be placed on top of the plywood to sound-proof the layout, but will require the use of longer screws to reach the wood underneath.

### Lionel Track Pliers

When working with Lionel track it is frequently necessary to remove track pins in order to move them to the opposite end of the rails, to replace steel pins with insulating pins, and to reshape distorted or enlarged rail openings.

All these jobs, including cutting and stripping of connecting wires, can be accomplished quickly and easily with special Lionel No. ST-384 Service Track Pliers recently designed by Lionel and now available to model railroaders by mail from the Lionel Service Department for \$3.25. The pliers will fit both "O" and "027" track, switches and crossings. Top picture shows how the plier jaws are shaped to round the rail and to crimp pins tightly in the rails.

To pull out track pins grip the pin with the cutting edge and pry it out, using the rail flange as point of rotation.

To reshape a distorted rail insert it into the forming hole of the pliers and squeeze it into shape. Doing this before the pin is inserted will result in a tighter-fitting pin.

To crimp a pin in the rail, insert the pin to the proper depth, line up the little projections in the plier jaws with the groove in the pin and squeeze.

### Insulated Track Sections

Special track sections which have one insulated outside rail are frequently used by model railroaders in permanent layouts instead of 145C and 153C contactors to accomplish automatic operation of semaphores, block signals, gatemen and other track accessories. Several applications of these track sections are illustrated on pages 9 and 10.

Such control sections are made for "Super-0" track as No. 48 straight and No. 49 curved. They can be easily made from regular "O" or "027" track, as shown below. Remove one outside rail, insert pieces of adhesive tape inside the clips of the track tie and replace the rail, bending down the track tie clips tightly. To complete the insulation of this rail fibre pins are inserted in both ends of the rail. Connections to it can easily be made by means of a track lockon attached on the side of the insulated rail. No. 2 lockon clip will then be connected to the insulated rail.

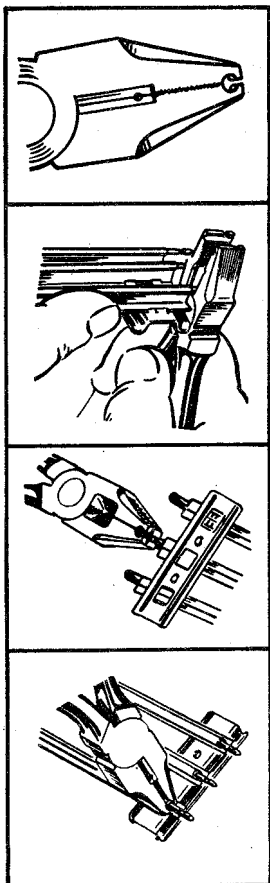
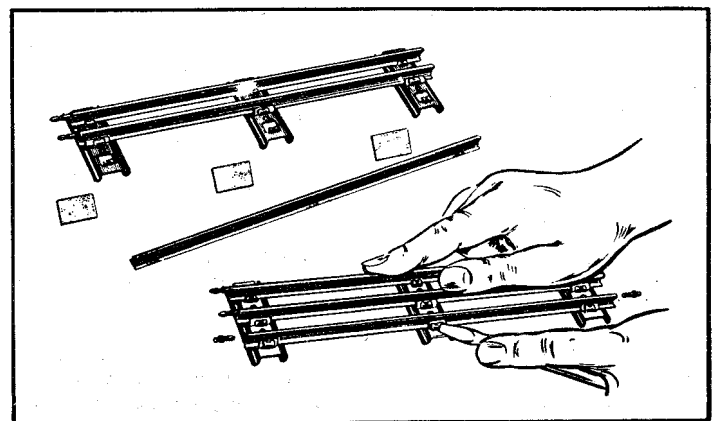

"Wipe Your Track Regularly"

## Intermixing Lionel Track and Equipment

Because of the differences in the three types of track intermixing them in a layout cannot be done without providing for the differences. To combine "0" and "027" track, the "027" track has to be raised 1/4 inch to bring its rails to the level of "0" rails. Because the rails themselves are of different diameters "0" track pins must be filed down on one end so that one end can fit the "0" track, while the other end fits the "027" track.

"Super-0" track and switches can be combined with either "0" or "027" track through the various transition pieces illustrated below so that "Super-0" track components can be combined with the other two types of tracks, making it possible to convert from one type of track to another gradually, saving the relatively expensive switches.

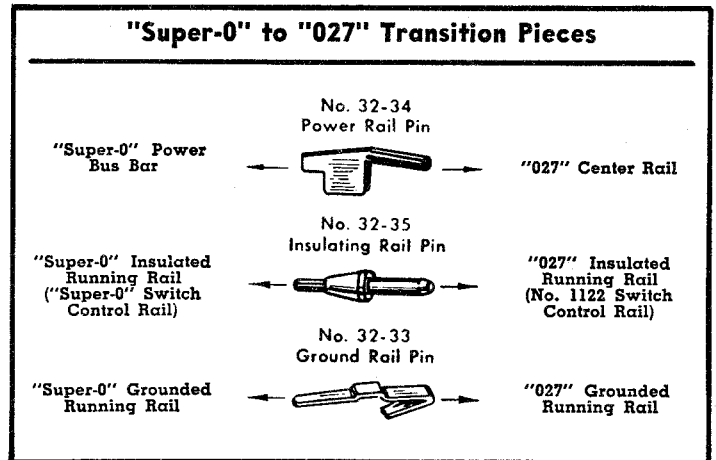
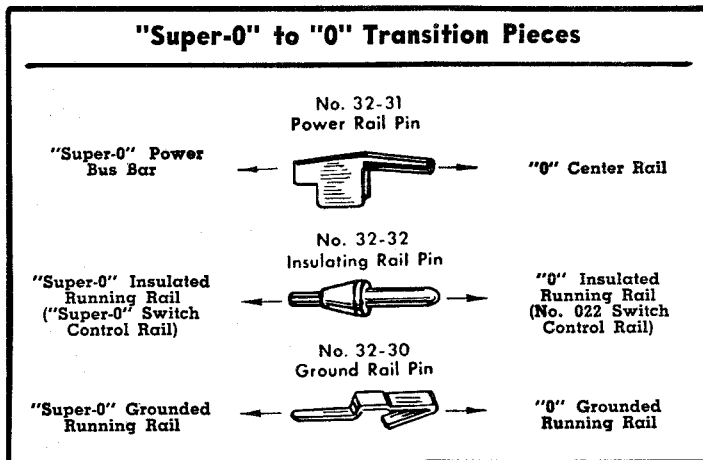

## PART THREE

### MULTIPLE TRAIN OPERATION

If you wish to operate two or more trains on the same railroad system, your layout should be designed to prevent one train from overtaking and running into the train ahead.

#### One Loop with Insulated Blocks

The first method explained here requires only one track loop in which one or more insulated track blocks are constructed and connected to the transformer through 153C contactors. The contactor is installed several sections away from the insulated block so that the first train passing over the contactor automatically cuts out the power from the insulated block behind it and forces the following train to come to a stop until the first train is safely out of the way. To add interest to this operation a 353 Control Signal or 151 Semaphore can be connected to the 153C Contactor to indicate whether the block is "live" or "dead".

*Note:* When two trains are operated in this way their reversing "E-Units" should be disconnected so that the locomotives do not reverse automatically. (For description of a method to preserve automatic reverse see page 17.)

An insulated block is made by taking out the metal track pins from the center rail of both end sections of the block and replacing them with insulated fibre pins. The block should be at least 3 track sections long so that the train does not coast through a "dead" block. The contactor should be placed far enough ahead of the block (3 or 4 sections) so that it is not activated by the weight of the waiting train.

In an average-size layout where only one or two blocks are used it is advisable to set the block voltage 2 or 3 volts higher than the rest of the track, so that the waiting train can get a fast start. This is done by using two different transformer circuits having a common "ground" post connected to the outside rail of the rail system. See page 22.

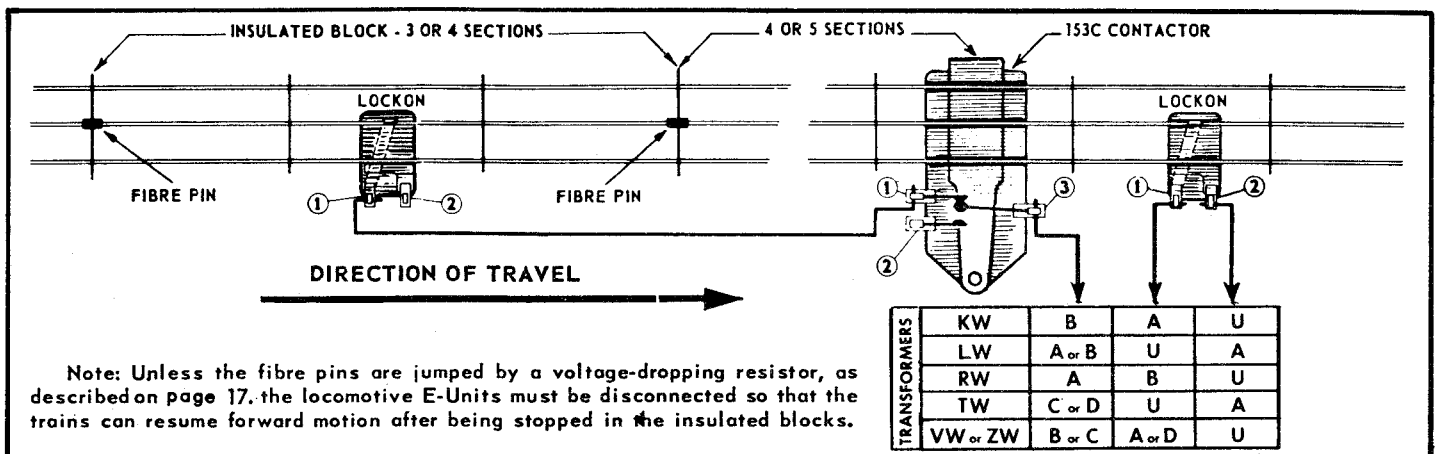

*Note:* Unless the fibre pins are jumped by a voltage-dropping resistor, as described on page 17, the locomotive E-Units must be disconnected so that the trains can resume forward motion after being stopped in the insulated blocks.

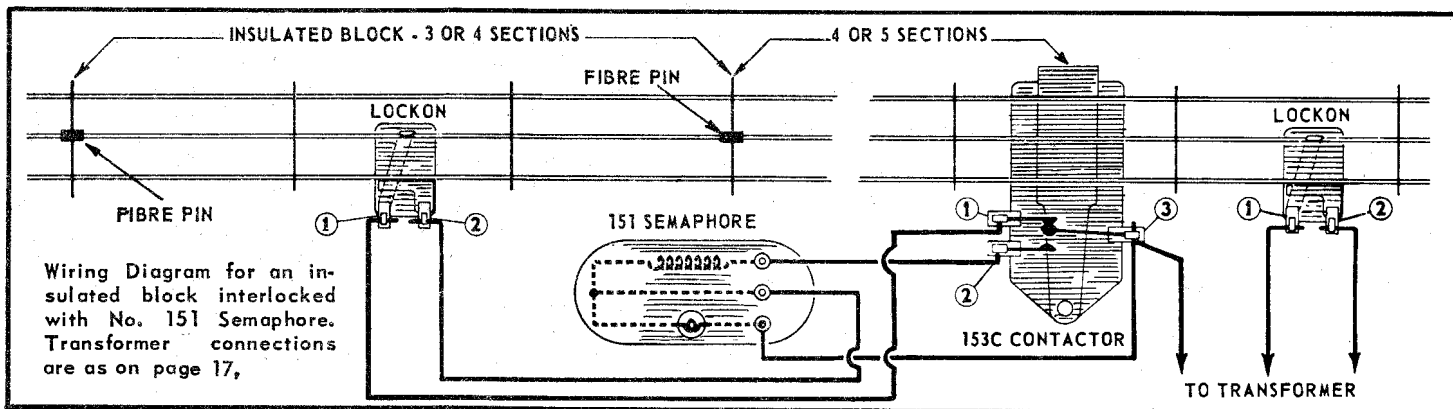

When running two trains on the same layout it is important that they operate on approximately the same voltage, or the faster train will tend to catch up with the slower

train before reaching the insulated block. Some of the variation in the speed of the two locomotives can be compensated by loading down the speedier train.

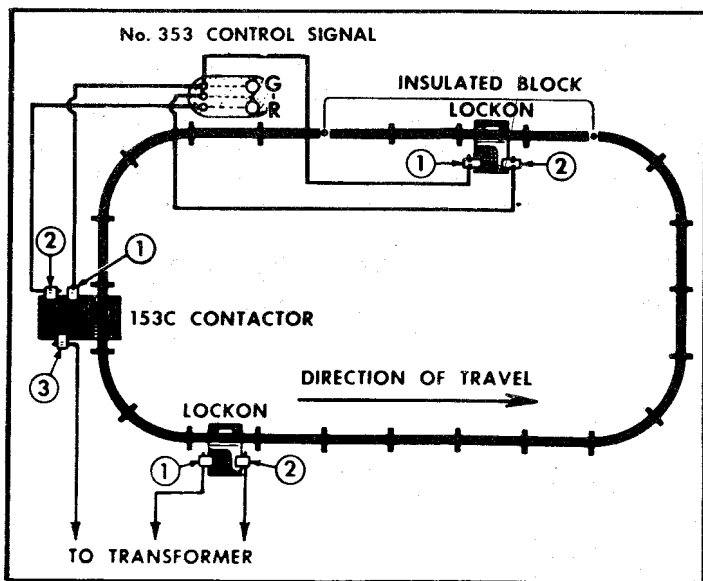
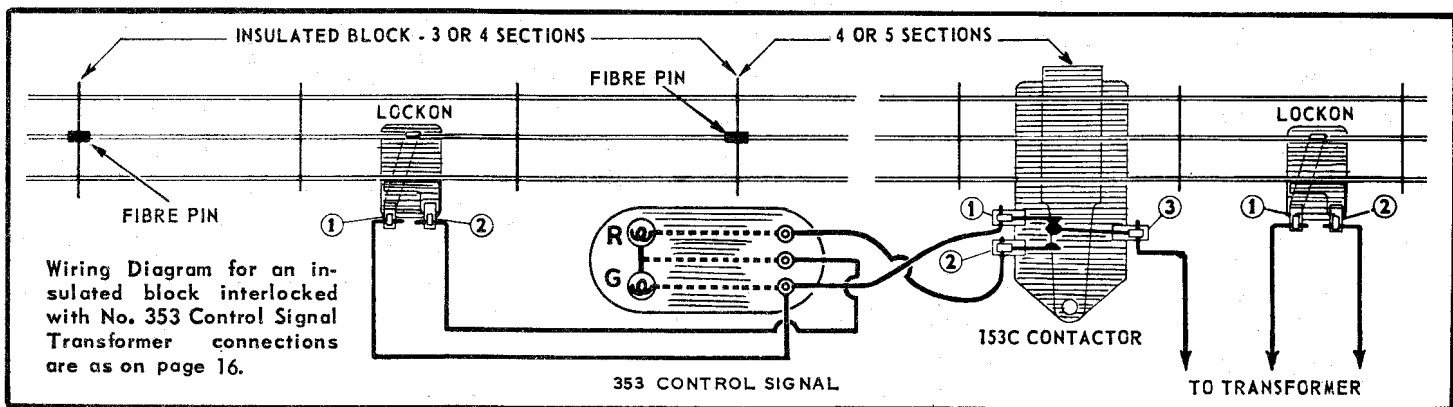

In the oval layout above, the insulated block is normally "live" so that both trains operate continuously unless the second train gets too close to the first train. When this happens the second train stops in the block until the first train pulls far enough ahead. The Block Signal indication is normally green.

In "figure 8" layout on the right the insulated block is wired to the contactor so that it is normally "dead". This forces the train reaching the block in front of the crossing to stop and wait until the other train crosses in front of it. The signal is red, changing to green only when the moving train reaches the contactor.

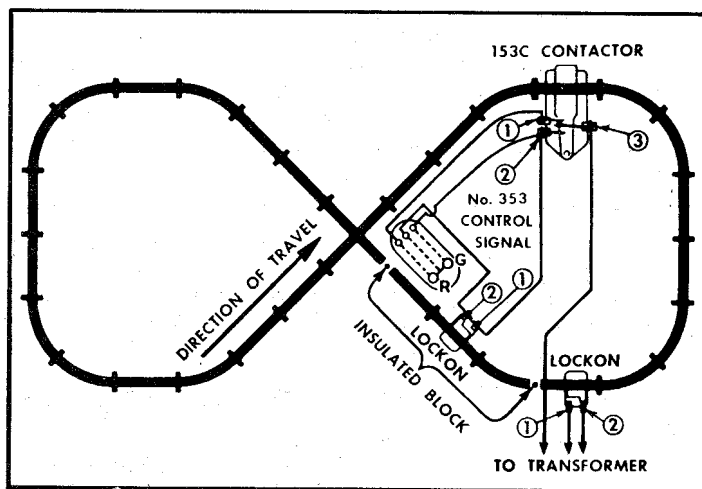

### Preserving Reversing with Insulated Blocks

A scheme which is sometimes used in large layouts to preserve the reversing feature of the locomotives even though insulated blocks are used, is to "jump" the fibre pin into each block with a 5-ohm 25-watt adjustable resistor available at radio and television supply stores. The resistor is then adjusted to permit just enough current to leak into the insulated block to keep the reversing unit energized but not enough to operate the motor. With this installation the blocks have to be somewhat longer.

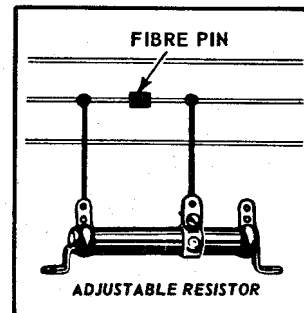

## Separate Insulated Loops

A second method for running several trains on the same railroad system is to arrange two or more complete loops insulated from each other by means of a fibre pin in the center rail of the track line connecting the two loops. In this system the center rail of each loop is connected to an individually controlled track voltage so that each of the trains can be controlled without interfering with the others.

An "O" layout of this type, designed to fit on a 4' by 8' platform and suitable for operating as many as three trains, is illustrated below. Note that in addition to the two insulated loops this layout contains two insulated blocks, one located in the connecting track on the right, and one in the right hand portion of the inner loop.

The block in the connecting track can be used as a siding to hold a train while two other trains run in the inner and outer loops. The block in the inner loop is used to hold a train while another train enters into the left half of that loop. The power to the two insulated blocks is controlled by a pair of No. 364C controllers or any off-on switches which are available in hardware or electrical supply stores and from radio and television supply mail order houses.

If desired, the insulated block in the inner loop can be connected for automatic control through a 153C contactor as described in previous section and another similar automatic control block added in the outer section as well, to permit collision-free operation of two trains in either loop. A double-throw switch may be provided to switch from manual to automatic operation, as "S2" on page 19.

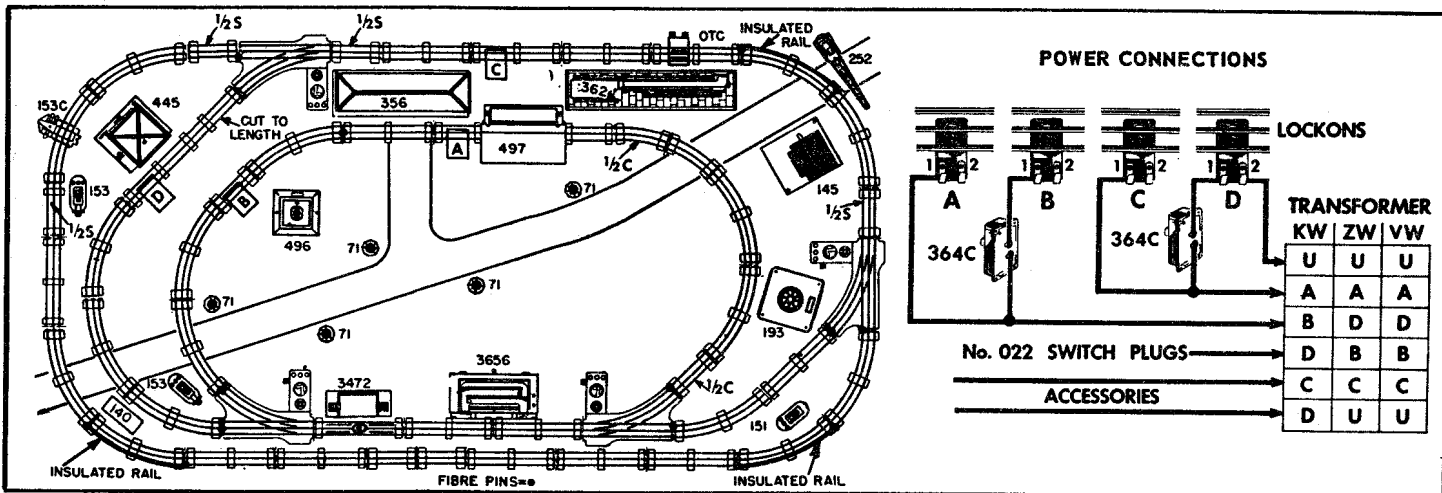

The "O" layout on this page is designed to fit on a standard ping-pong table which measures 5 feet by 9 feet. Like the layout on the preceding page it is sectionalized by the insertion of insulating pins at points indicated by arrows.

Two trains can run continuously and be independently controlled on the track loops fed through lockons A and C. There are also two freight sidings supplied through lock-

ons D and E and a block connecting the two main loops and supplied through lockon B. The two sidings and the connecting track are wired through off-on switches so that a train can be halted in any of these locations.

Note that the addition of a curved section and a left-hand switch at the end of the siding D can convert this siding to a reversing loop enabling a train to change its direction.

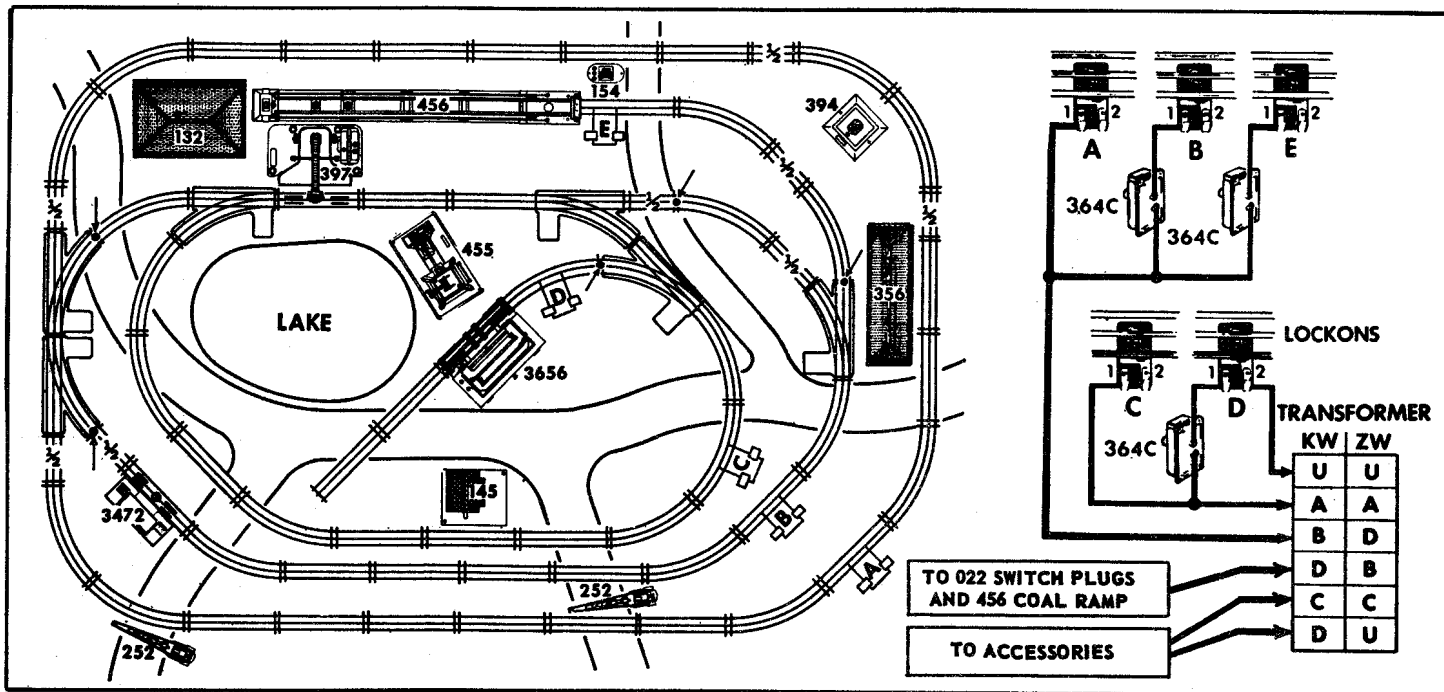

- LEGEND**
- |               |              |
|---------------|--------------|
| AMOUNT TO USE | Catalog Nos. |
| 47            | 31           |
| 73            | 32           |
| 11            | 33           |
| 2             | 34           |
| 3             | 36           |
| 4             | 37           |
| 10            | 38           |
| 7             | 260          |
| 1             | 48           |
| 1             | 49           |
| 7             | 61           |
| 7             | 62           |
| R.H. 4        | 112          |
| L.H. 4        |              |
- TRESTLE PIER  
 CENTER RAIL INSULATOR

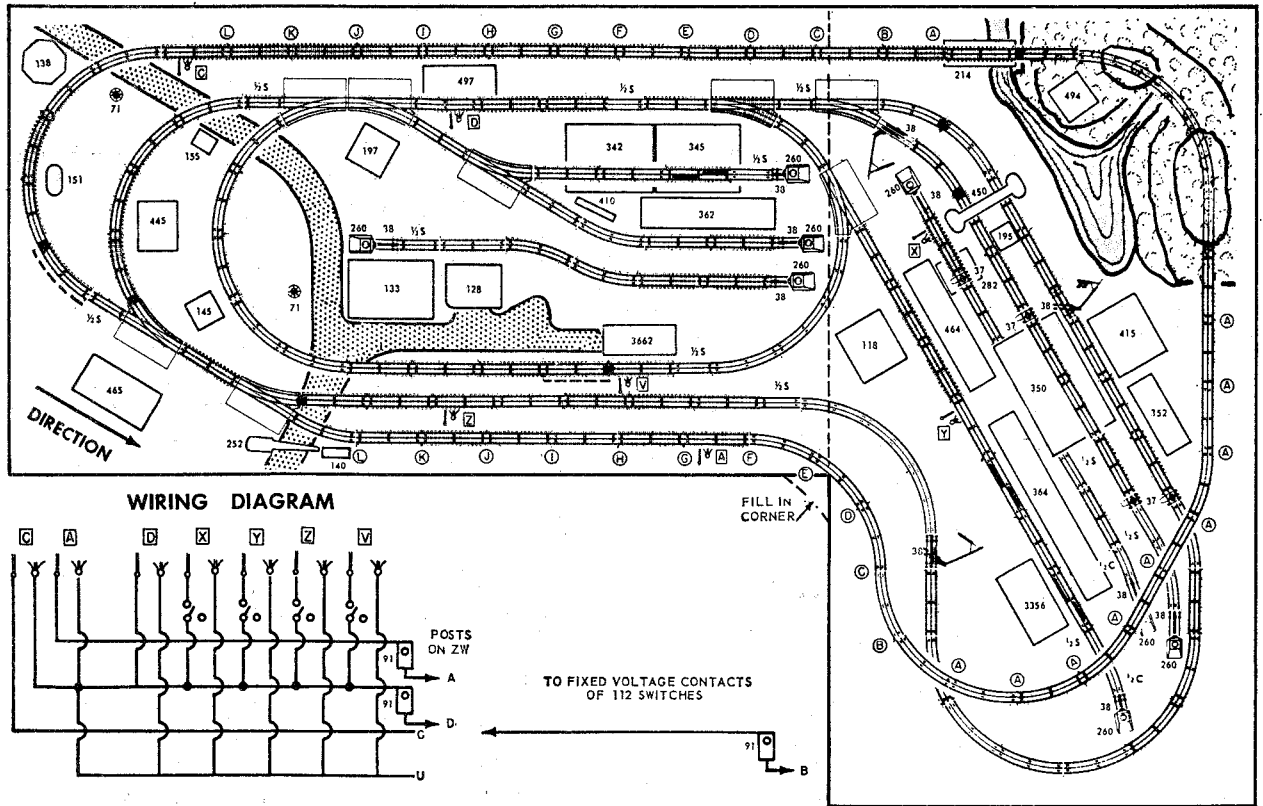

This "Super-O" L-Shaped layout fits on two 9' x 5' platforms. Use Auxiliary Transformer (TW) for accessories such as No. 350 Transfer Table, Trolley Siding, etc. The two transformers should be "Paralleled" by connecting "U" on ZW to "A" on TW and inserting transformer plugs in "Parallel." (If transformers "Buck" each other invert one of the plugs).

### A Complete Block System

Through the use of relays it is possible to build up a complete blocked-out railroad system which would permit several trains to follow each other without danger of rear-end collisions. The diagram below illustrates one such system. Note that this represents an oval track separated into 5 blocks. (Block No. 5 at the left is the same Block No. 5 at the extreme right.)

The action in this system is this. Let's say a train has just pulled into Block 2 from Block 1. As soon as the locomotive hits the insulated control rail (heavy line) relay 1 closes, cutting out the track power from Block 1 and at the same time changing the indication on Signal 1 from green to red.

This, of course, means that any train entering Block 1

from Block 5 will simply coast to a stop within Block 1 and wait there until the train ahead is entirely clear from the control rail in Block 2. As soon as the control rail is clear, relay 1 snaps back into normal position, restoring track power to Block 1 and changing the signal from red to green.

To prevent "chattering" of the relays, the control rail in each block should be at least two track sections in length so that at least two sets of car wheels are on it at all times.

To safeguard the relays against heavy short-circuit current in cases of accidental derailments the variable voltage line should be protected with a No. 91 circuit breaker. Otherwise, a heavy surge of current delivered by a KW or a ZW transformer can burn out the flexible leads within the relays. No. 91 Circuit Breakers are described on page 24.

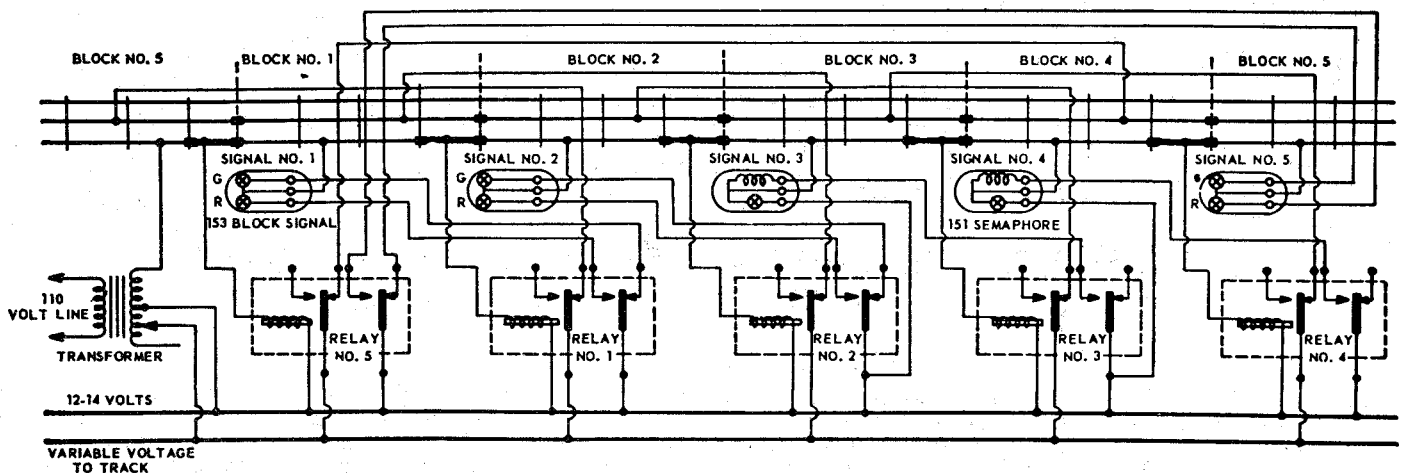

# GRADED LAYOUTS

## No. 110 Trestle Set

No. 110 Trestle Set consists of 12 pairs of graduated trestle piers or "bents" which raise the track from ground level to a height of approximately 5 inches, which is the clearance required for Lionel rolling stock. The bents are placed one full track section apart so that each bent supports the joint between two track sections. The bents are lettered from "A" to "L", with "A" being the highest.

The trestle set can be used in many different layouts, with some of the smallest possible illustrated on this page. Note that 23 sections of track are required for complete up and down grade. To extend the top level, an auxiliary Trestle Set No. 111, consisting of ten "A" bents, is also available at your Lionel dealer.

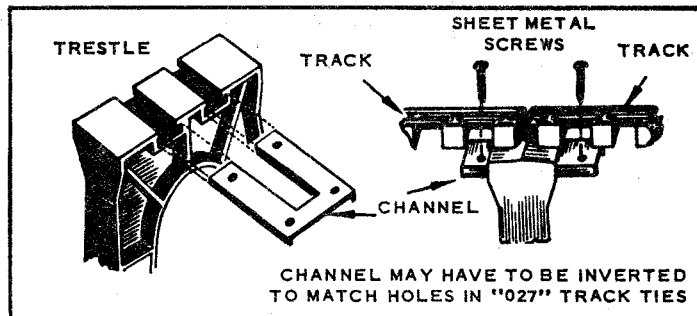

How to Fasten Track To Top of Trestle. The Trestle Can Be Mounted to the Table by No. 4 or 5 Wood Screws.

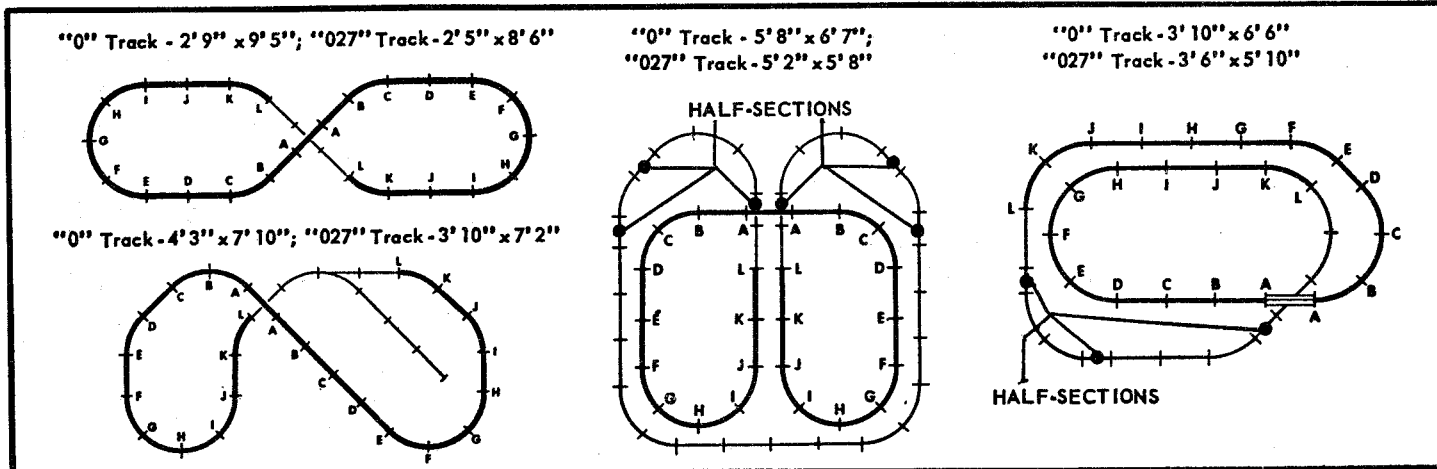

Typical "Over and Under" Layouts Which Can Be Made with One No. 110 Trestle Set. The Elevated Portions of the Track Are Shown in Heavy Line.

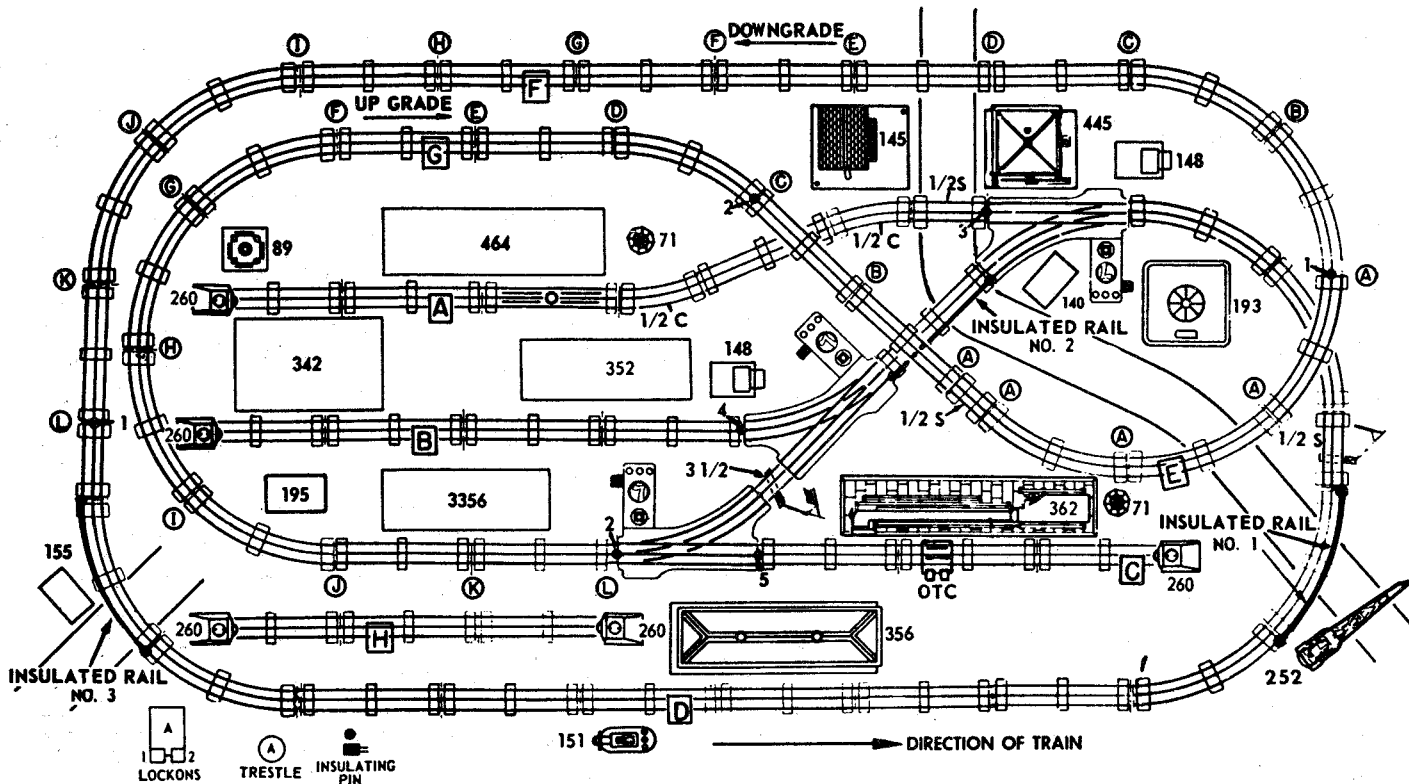

### FOR "0" OR "027" TRACK

Since No. 110 Trestle Set requires 23 sections of track to come to its full height and to return to level, a standard 4 x 8 plywood board does not offer room for too many variations of track design. However, the layout above not only

permits the use of a full trestle set but also leaves room for a well-developed freight yard and even a separate trolley line located in the lower portion of the track plan.

In this layout all the sidings are insulated and two of



## Schematic Wiring Diagram for Track and Accessory Connections

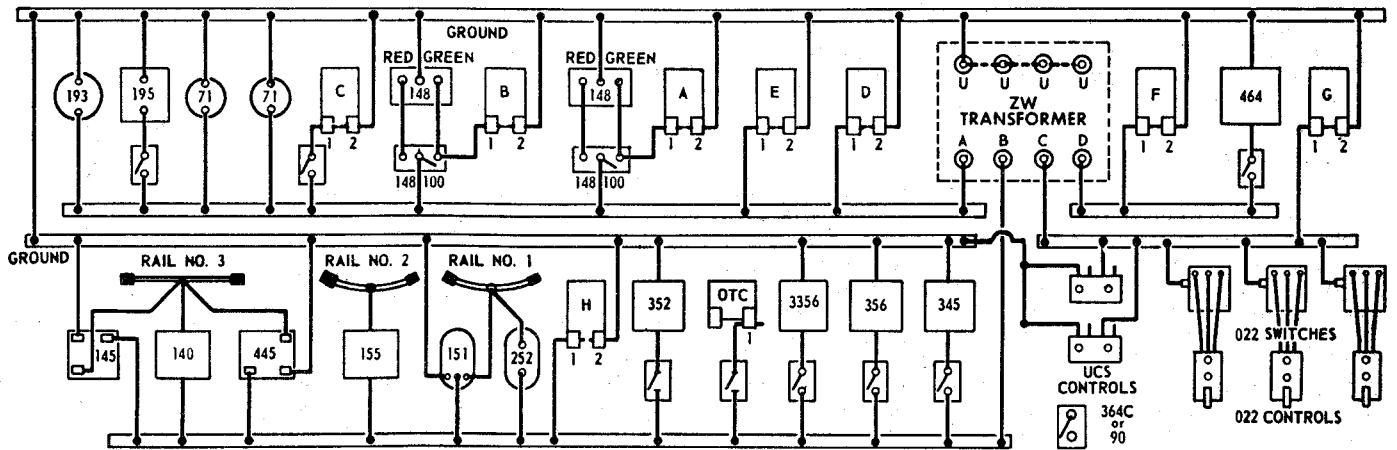

them, insulated by pins 3 and 4, are interlocked with No. 148 Dwarf Signals. The automatic signals and accessories are operated by means of insulated rails, shown in heavy black line. The upgrade and downgrade portions of the main track are also insulated (pins 1-1 and 2-2) and are supplied with separate track voltages which can be adjusted to keep the speed of the train even all around the track. The schematic diagram above illustrates the wiring of such a layout. Each strip represents a bus bar connected to a transformer terminal and running the full length of the board. The leads to each accessory and track lockons are then soldered to the bus bar at the nearest or most convenient point.

All the controls should be grouped together on a control board. Where there are a number of controllers all connected to the same source of voltage as in the case of the five

controllers in the center of the lower section, it is frequently convenient to use another bus bar underneath the control panel.

In this diagram note that transformer post A supplies track voltage to all level track, including the sidings, each of which is fed through an off-on switch. Voltage for most accessories is derived from post B. Post C is used to provide higher voltage used for switches, uncoupling track sections, and the upgrade portion of track. Post D is set to provide low voltage for the downgrade portion and also for No. 464 Lumber Mill which operates best on fairly low voltage. Although not indicated on the diagram, lockon H, which feeds the separate trolley line, can also be connected through an off-on switch such as No. 364C, as can also the street lamps and No. 193 Flashing water tower.

## ABOUT YOUR POWER SUPPLY

A few words about electricity may help you understand some of the electrical terms which are used in describing the operation and requirements of your Lionel electric trains, transformers and other equipment.

The three most commonly used electric units of measurement are amperes, volts and watts.

*Amperes* are used to measure the quantity of electric current flowing through a circuit.

*Volts* are used to measure electric pressure.

*Watts* are used to measure electric power. For the purposes of rough estimates in alternating current circuits they can be calculated by multiplying amperes by volts.

If you compare the flow of electricity to the flow of water from a squirt gun you can see that the more pressure you put on by squeezing the trigger the faster will be the water jet, and the more water you will be able to get out of the muzzle opening.

In the same way increasing the voltage will send more electric current through the wires and the motor. With the pressure or voltage kept even, the amount of current—either water or electric—that will flow through the system naturally depends on the size of the opening, or the thickness of the wires used in the circuit.

### Alternating and Direct Current

Two terms that are used very often to describe electric current are Alternating Current (A.C.) and Direct Current (D.C.). Direct current is the kind that flows in one direction only—from Positive (+) to Negative (—). This is the kind you obtain from electric batteries. Alternating current is produced by electric generators and changes the direction of its flow many times a second according to its frequency (CYCLES). This is the usual type of current used in your house mains. The house electric supply generally used in the United States is 115-volt, 60-cycle alternating current. Some parts of California use 50-cycle

current; some areas in Canada and upper New York State use 25-cycle current; while some downtown areas in New York City still use 115-volt Direct Current (D.C.).

**A transformer should never be plugged into a Direct Current line or it will either burn out itself or blow out the fuse.**

High voltage Direct Current requires the use of an *inverter*, which changes direct current into alternating current. The inverter is first plugged into the wall outlet; the transformer is then plugged into the inverter. Lionel has not made inverters since the war, but they are readily available elsewhere.

### What a Transformer Does

Because 115-volt line voltage is dangerous to use in toys, Lionel Trains are made to run on low, completely safe voltage ranging from 8 volts to 25 volts, depending on the type and size of the locomotive. This low voltage must be obtained from a step-down transformer which changes your household voltage to the low safe voltage.

The transformer basically consists of two coils of insulated copper wire, each separated from the other but wound around a common core of electrical steel. One of the coils—the primary—is wound with many turns of fine wire and is connected to the household electric outlet. The other coil—the secondary—is wound with fewer turns (approximately 1/5) of heavier wire.

When the primary coil is plugged into an A.C. household line, the alternations of the primary voltage are reflected in the secondary coil and induce a low secondary coil voltage used to run the train and accessories.

Because the secondary voltage is reduced from the primary in the same ratio that the number of turns in the secondary winding has to the turns in the primary winding, a provision is usually made to "tap" the secondary winding at several points so that several different "fixed" voltages can be obtained.

In addition, Lionel transformers have a movable contact arm which slides across the bared surface of a portion of the secondary winding. This makes it possible to "tap" the secondary winding at any turn of wire and provides the means for obtaining a smoothly variable voltage used for accurate control of train speed without the use of resistors, rheostats or other power-wasting voltage-dropping devices.

### What Causes Voltage Drop

The "fixed" voltages marked on your transformer panel or the voltages indicated by your transformer voltage control at any particular setting are almost never the actual voltages delivered to your track or your accessories. The reasons for this variation are several. The voltages marked on your transformers are "nominal". That is, they are accurate only under certain specified conditions: when the line voltage fed into a 115-volt transformer is just 115 volts and when *no current is drawn* from the transformer. Actually, the line voltages may vary from 125 to 110 volts, or even lower, depending on the standards in your locality and on how much electricity is being used at a particular time. This variation, normally, results in the same percentage reduction of the output voltage of the transformer. If your train seems to run slower toward the evening it's probably because thousands of people of your neighborhood had switched on their lights and household appliances and so depressed the line voltage.

In the same way that a heavy demand for power may lower the voltage in your neighborhood, a heavy load on your transformer lowers its output voltage as well. For example, the fixed binding posts which are marked 14 volts may, under actual operating conditions, deliver only 12 volts, or even less. In the case of a severe overload such as caused by a short circuit on the track so much current is drawn from the transformer that its voltage drops to 2 or 3 volts—too low to operate the train or even light the lamps.

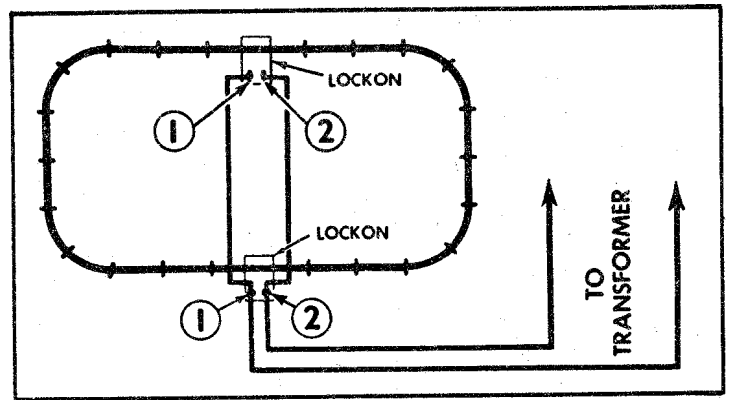

### Using Auxiliary Lockons

In operating large layouts it is frequently found that the train slows down when running on the portion of track farthest from the Lockon. This is due to voltage losses in the track itself and can be remedied by attaching additional Lockons at the points on the track where the train slows down. Be careful to connect the No. 1 and No. 2 clips of the auxiliary Lockons to similarly numbered clips of the Lockon connected to the transformer to avoid a short circuit. In "Super-0" layouts all you have to do is insert several additional No. 62 power connectors joining them with a No. 18 copper wire.

The main part of voltage losses in the track is due to loose track pins. These loose connections can be frequently detected by the heating effect of poor electrical contacts. After the layout has been in operation for a half hour or so, run your finger down the rails. Loose rail joints will then become apparent as hot spots on the track.

In large permanent model railroads short copper wire "jumpers" are frequently soldered across the track pins.

### Circuits with Common Ground

In model railroading there are numerous occasions when it is desirable to apply different voltages to accessories or track components which have a common "ground" with the rails of the track system. Examples of this usage are fixed voltage plugs of No. 022 switches, No. 112 switches, remote control track sections operating on fixed voltage, insulated track blocks used in multiple train operation, upgrade or downgrade portions of track requiring higher or lower voltage than level track.

To prevent short circuit condition in all such cases it is important to select transformer circuits which also have a common ground. The chart below lists various circuit combinations which are available in modern Lionel transformers. The voltages specified are the nominal or "no load" voltages and drop somewhat under operating conditions.

Transformer	With this as Common or Ground Post	These are the Fixed Voltage Posts	And these are the Variable Voltage Posts
1032, 1033, 1044 Multi-Control	A	C 16 V. B 5 V.	U 5-16 V.
	B	C 11 V.	U 0-11 V.
	C	A 16 V. B 11 V.	None
	U	None	A 5-16 V. B 0-11 V.
'KW' Multi-Control	U	D 20 V. C 6 V.	A 6-20 V. B 6-20 V.
	C	D 14 V. U 6 V.	A 0-14 V. B 0-14 V.
	A	B 18 V. C 14 V.	U 6-20 V.
'LW' Multi-Control	A	B 18 V. C 14 V.	U 6-20 V.
'VW' 'ZW' Multi-Control	U	None	A* 6-20 V. B 6-20 V. C 6-20 V. D* 6-20 V.

\*With Internal Whistle Control

'TW' Multi-Control	A	C 18 V. D 14 V. B 7 V.	U 7-18
	B	A 7 V.	U 0-11

In addition this transformer has 2 posts marked E and F which furnish an independent 14 V source to supply lights, accessories, etc.

The following table lists the fixed voltage circuits which can be obtained from some of the most popular Lionel transformers made in recent years.

'A', 'Q'	A	C 14 V. B 8 V.	U 14-24 V.
	B	A 8 V. C 6 V.	U 6-16 V.
	U	None	A 14-24 V. B 6-16 V.
'R'	A	D 14 V. B 8 V.	C 14-24 V. F 14-24 V.
	B	E 16 V. A 8 V.	C 6-16 V. F 6-16 V.
	D	A 14 V. E 10 V.	None
'RW' Multi-Control	A	D 19 V. C 9 V.	U 9-19 V.
	B	D 16 V. C 6 V.	U 6-16 V.
	D	A 19 V. B 16 V. C 10 V.	None
	U	None	A 9-19 V. B 6-16 V.
'V' 'Z'	U	None	A 6-25 V. B 6-25 V. C 6-25 V. D 6-25 V.

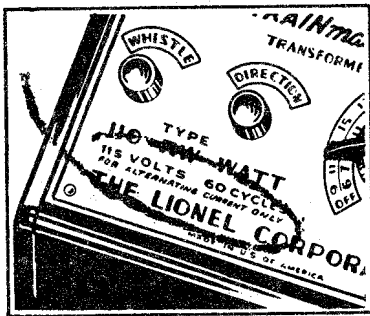

### Transformer Rating

Regular Lionel transformers are designed to work on 110 to 125 volt, 60-cycle alternating current. Other combinations of voltage and frequency (cycles) require special transformers, which are generally available from Lionel dealers located in areas having these special conditions. The voltage and

frequency ratings of transformers always appear on the transformer panels. Transformers can be operated on frequencies which are higher than their rated frequencies (a 25-cycle transformer will operate on 60 cycles, for example), but the reverse of this is not true. If a 60-cycle transformer is plugged into a 50-cycle or a 25-cycle line it will overheat and may be seriously damaged.

### About Wattage

In addition to their voltage and frequency ratings, transformers and other electrical equipment also bear a wattage rating. The wattage of a toy transformer is a measure of the maximum amount of electric power which it can take from the household power lines without overheating.

The thing to remember is this: You have no control over the *voltage* and *frequency* rating of the transformer you need because that is determined by the available household current supply. You do have control over the *wattage* rating of the transformer you select. In this selection you must be guided by the size of your railroad system and the number of trains, lights and accessories you will use.

*It is always wisest to get a transformer larger than the one you require for your immediate needs in order to provide power for future expansion.*

### How to Estimate Your Power Requirements

While electric power is normally calculated in watts, you can obtain a very close approximation of the requirements of your model railroad by adding up the current, in amperes, consumed by your equipment, counting 1 1/4 amperes for each motor, and 1/5 amperes for each steadily burning lamp.

You do not need to figure in the power requirements of automatic couplers and operating cars, since the couplers draw current for only an instant and operating cars only when the train is not running. For the same reason, do not add power used by such accessories as coal elevators, log loaders and other operating devices which are put in action when the train is not running.

Even with a small transformer your layout can contain as many operating accessories as you wish provided that you operate them one at a time.

For example, if your outfit consists of a 5-car illuminated passenger train pulled by an "0" gauge twin-motored locomotive, and you have a pair of No. 022 switches, 4 lamp posts and a couple of block signals you could make a table, as follows:

Equipment	Quantity	Current	Total
Motors	2	1.25	2.5
Headlights	2	.2	.4
Car lights (2 in each)	10	.2	2.0
Switch lights	2	.2	.4
Switch controllers	2	.2	.4
Block signal lights	2	.2	.4
Total current			6.1 amps.

This would mean that your outfit would require a continuous current of approximately 6 amperes and would call for a KW or a TW transformer.

Again, note that installation of several operating units such as a No. 356 Station and a No. 350 Transfer Table will have practically no effect on your power requirements.

### How to Estimate Available Power

As stated before, the wattage rating of a transformer tells you how much power it will take from your household mains. However, all of this power is not available for your train. From about one-quarter to one-eighth of the total wattage taken from the lines is used up by the transformer itself in transforming the power from high to low voltage. This wattage loss becomes apparent in the warming up of the transformer as it is used.

A transformer operating continuously for long periods of time or in warm surroundings will be able to deliver less power than one used intermittently or in cool surroundings. As the transformer warms up in use its output voltage and wattage will drop gradually.

As an example, a 90-watt No. 1033 transformer should not be used to deliver more than 60 watts of usable low-voltage power. A 275-watt ZW transformer should not be counted on to supply more than 200 watts. It is important to take this loss into consideration when estimating the amount of equipment your transformer can operate.

Another and simpler way to determine the amount of equipment which you can add to your train layout is by considering the amount of current, in amperes, which can be supplied by your transformer continuously, without overheating. The following table lists the current which can be supplied by Lionel transformers for at least four hours of continuous operation, under normal temperature conditions.

Transformers	Amperes
1015	2.5
1043-1053-1063	3.0
1033-1044	4.0
LW	5.5
KW	8.0
TW	8.0
ZW	12.0

### How to Connect Transformers in "Parallel"

When the power requirements of a model railroad are so large that more than one transformer is needed, the best practice is to use one transformer to furnish variable voltage for the track and reserve other transformer for lights and accessories. In some cases, however, when several trains are operated at the same time in various insulated sections of system, it might be necessary to use more than one transformer for the track itself.

To connect two transformers to the track they must be properly "phased" so that the high and low peaks of their alternations coincide. If they do not, a short circuit will be created whenever locomotive contact rollers bridge across a fibre pin separating two insulated portions of track.

To "phase" two transformers proceed as follows: Connect the "U" binding post from each transformer to the No. 1 clip of a lockon attached to a piece of track. Set the output voltages of the two transformers at the same point and plug the transformer cords into a wall outlet. Then touch together a pair of wires leading from the "A" binding posts. If you get a strong spark indicating a short circuit *reverse the plug of one of the transformers*. Once you have determined the correct position of the two plugs mark them in some way so that you will be able to connect them correctly in the future. You can connect the two transformer cords permanently by wiring them to the same plug.

When the transformers are in phase their ground or common posts can be connected to the outside ground rail, and the available voltage circuits used to supply several different voltages required by the various insulated portions of the center power rail.

Even when the transformers are in phase, however, you must be careful to set the voltage of the two adjacent sections at approximately the same point when transferring a locomotive slowly from one circuit to the other. Otherwise its rollers may bridge the insulating pin long enough so that the partial short created at that moment will stop the locomotive.

## How a Circuit Breaker Works

With the exception of No. 1015 transformer supplied with several starter train sets, all Lionel transformers are equipped with built-in thermostatic circuit breakers. Circuit breakers of this type depend on the heating effect of electric current. Whenever the current drawn from a transformer exceeds a certain limit, it overheats a thermostatic bi-metal strip or disc within the circuit breaker and snaps it open, cutting off the output of the transformer. In a few seconds the circuit breaker cools down and closes automatically. It will keep on opening and closing in this way as long as the transformer is overloaded—as by a short circuit or another excessive load.

The purpose of the circuit breaker is to protect the transformer and it operates only if the transformer is overloaded. In large layouts it is possible for the track to be "shorted" without causing the circuit breaker of a large and powerful transformer to operate. However, no injury can occur to the transformer in this event, because it is not being overloaded even though the voltage in the shorted portion of the track may drop down below the operating point of the train.

### No. 91 Circuit Breaker

Lionel No. 91 Circuit Breaker differs from the regular built-in breakers in being electro-magnetic instead of thermostatic. No. 91 Circuit Breaker does not depend on the heating effect of electric current but opens instantaneously the moment the current passing through it exceeds the

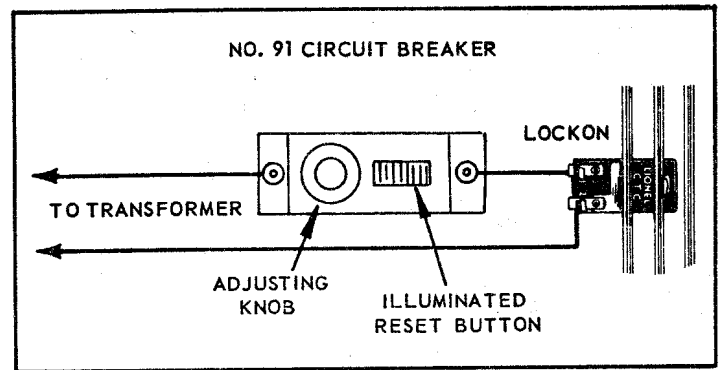

limit for which it is adjusted. It is adjustable to open on any current from 1 to 6 amperes, and has an illuminated manual reset button which lights up whenever the circuit breaker snaps open.

No. 91 Circuit Breaker has two main applications. The first is to protect transformers which are not equipped with their own built-in circuit breakers, such as No. 1015 Transformer, supplied with several "027" starter train outfits. The other application, most useful in larger or multi-train layouts, is to protect each train circuit separately. If you depend on the built-in transformer circuit breaker a short circuit or a derailment in any portion of the railroad will stop all traffic everywhere. However, if each train is protected individually its derailment will shut off power from its own branch alone, without interfering with the power supply to other sections. In this way the trouble can be quickly localized and corrected.

## HOW TO BUILD A MODEL RAILROAD

One of the most fascinating things about owning a miniature train is the planning and building of a model layout that has all the features of an actual railroad system. With Lionel's wide selection of tracks and accessories it is easy to duplicate any of the operations of the big roads. Like all hobbies, model railroading develops slowly. You can start with a layout that fits your income, and add to it gradually.

This booklet has a few ideas to get you started. You can get a great many more from the various model railroad hobby magazines available at your hobby or news dealer.

### Plan Your Layout Carefully

First step is to get out your pencil and put down a few ideas that will guide you in your planning. Where will your

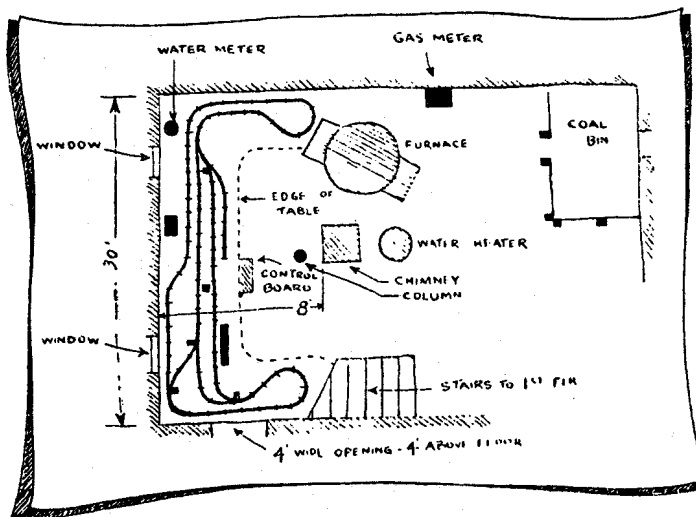

Overall size: 82" x 32".  
Track needed: 8 sections straight, 10 sections curved, pair of switches.

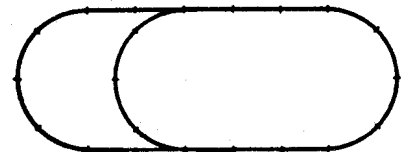

Overall size: 82" x 41".  
Track needed: 14 sections straight, 11 curved, 3 switches 1 remote control section.

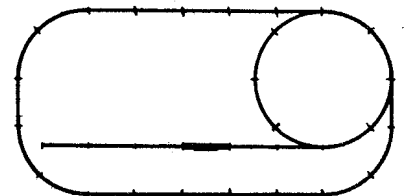

Overall size: 82" x 41".  
Track needed: 15 sections straight, 14 sections curved, one 90 degree crossing, one remote control section, 2 right-hand, 3 left-hand switches.

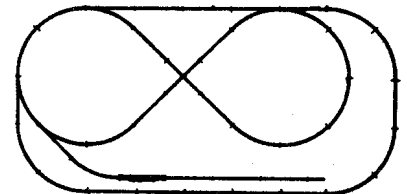

Overall size: 82" x 41".  
Track needed: 14 sections straight, 10 sections curved, 4 switches, 2 remote control sections.

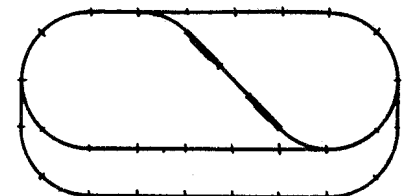

Here are a few of the simpler layouts. These are in "O" track. Similar "027" layouts will be ten percent smaller.

## "Super-0" Layouts

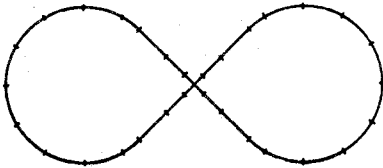

TYPE OF LAYOUT:  
Figure 8  
SPACE REQUIRED:  
38" x 89"  
TRACK REQUIRED:  
16 #31, 4 #33, 4 #32, 4 #34,  
1 #120

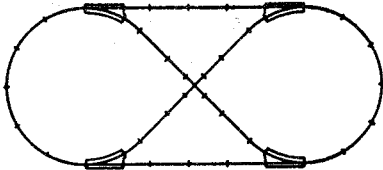

TYPE OF LAYOUT:  
Oval with double reverse  
SPACE REQUIRED:  
38" x 89"  
TRACK REQUIRED:  
12 #31, 4 #33, 10 #32, 6  
#34, 2 pr. switches, 1  
#120

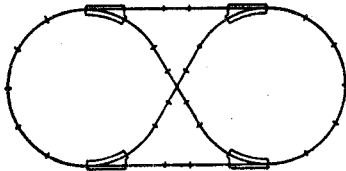

TYPE OF LAYOUT:  
Oval with double reverse  
SPACE REQUIRED:  
38" x 80"  
TRACK REQUIRED:  
16 #31, 4 #33, 6 #34, 2 pr.  
switches, 1 #130

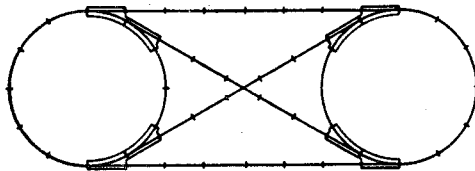

TYPE OF LAYOUT:  
Two-train layout with  
double reverse  
SPACE REQUIRED:  
38" x 100"  
TRACK REQUIRED:  
16 #31, 20 #32, 1  
#130, 4 pr. switches

layout be? In the cellar? The attic? A spare room? Sketch in the available space to scale and rough in a few ideas. To help you plan your layout accurately "0", "027" and Super "0" adhesive track and accessory templates are available free of charge from the Lionel Service Department. When writing for them please specify which templates you need.

When you plan your first track layout, be sure to allow for future growth of your rail system. As you add to your rolling stock you will want more sidings, classification and storage yards, reversing loops, freight and passenger terminals, industrial installations. The simple siding in today's layout may tomorrow become a complete new branch of your railroad empire.

## Elevate Your Layout

The ideal location for a permanent layout is on a large table or specially built "run-around" wall shelving. Floor layouts risk the perils of stepped-on track, they are awkward to get at and a problem when the floor needs cleaning.

Favorite spots for waist-level train setups are dry cellars, attics, spare rooms and garages. Sketches on page 51 illustrate several types of "closed" and "open" model railroad tables or platforms and also several different layouts suitable for one or two 4' x 8' plywood boards. Platforms can be cheaply constructed of old lumber or second-hand plywood. Plywood has definite advantages in that it requires little cutting or fitting and simplifies drilling of holes for hidden wiring. A sheet of celotex over the plywood will help sound-proof your layout. If you construct a table arrangement be sure that the legs are well cross-braced. Wall shelving, too, should be sturdily built to prevent sway and unsteadiness.

One of the principal reasons for the shelf or table layout is to bring model train operation to a realistic-view angle. Although there is some dispute as to the correct height from the floor, the general agreement is that 40 inches is about right for adults, a height of about 26 inches for the seven or eight-year-olds. For a father-and-son layout build a six-inch step to take care of the junior partner.

## LAYOUTS FOR TWO 4 X 8 FOOT PLYWOOD SHEETS

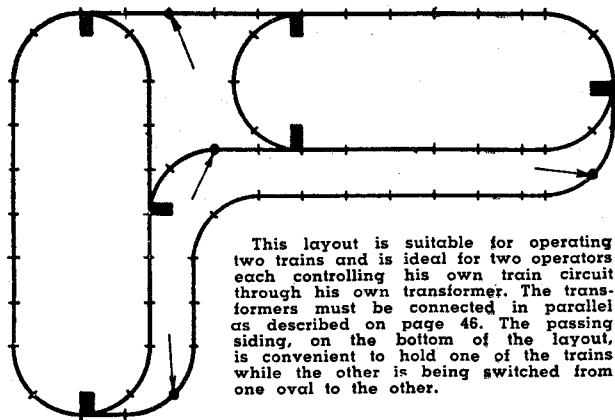

This layout is suitable for operating two trains and is ideal for two operators each controlling his own train circuit through his own transformer. The transformers must be connected in parallel as described on page 46. The passing siding, on the bottom of the layout, is convenient to hold one of the trains while the other is being switched from one oval to the other.

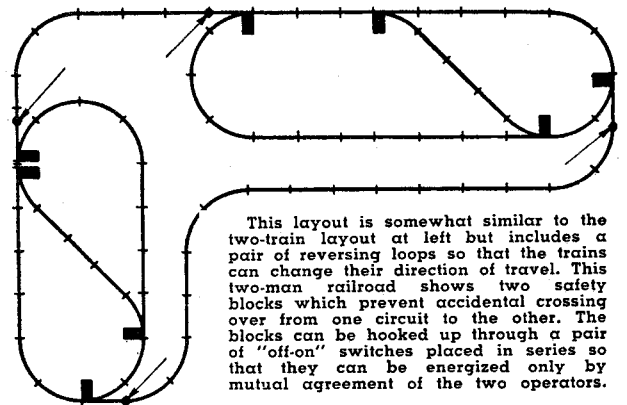

This layout is somewhat similar to the two-train layout at left but includes a pair of reversing loops so that the trains can change their direction of travel. This two-man railroad shows two safety blocks which prevent accidental crossing over from one circuit to the other. The blocks can be hooked up through a pair of "off-on" switches placed in series so that they can be energized only by mutual agreement of the two operators.

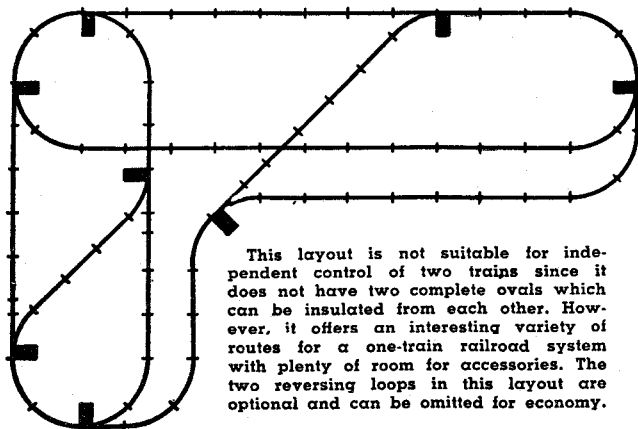

This layout is not suitable for independent control of two trains since it does not have two complete ovals which can be insulated from each other. However, it offers an interesting variety of routes for a one-train railroad system with plenty of room for accessories. The two reversing loops in this layout are optional and can be omitted for economy.

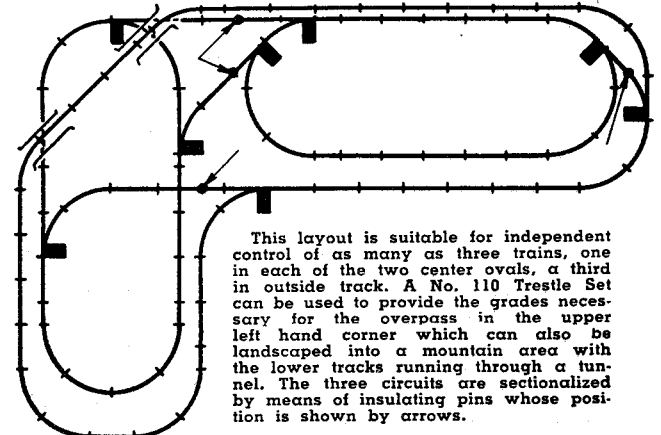

This layout is suitable for independent control of as many as three trains, one in each of the two center ovals, a third in outside track. A No. 110 Trestle Set can be used to provide the grades necessary for the overpass in the upper left hand corner which can also be landscaped into a mountain area with the lower tracks running through a tunnel. The three circuits are sectionalized by means of insulating pins whose position is shown by arrows.

"Wipe Your Track Regularly"

## Building Grades

To take full advantage of Lionel's "Magne-Traction" locomotives and to provide for excitement of overpassing trains you will undoubtedly want to have some graded mountain sections in your layout. Keep the grades as gradual as possible— $\frac{1}{2}$ " rise per section of track is as steep as you should go—and be sure they are anchored securely so that train vibration will not loosen them. Lionel's No. 110 Trestle Set will give you the ideal dimensions.

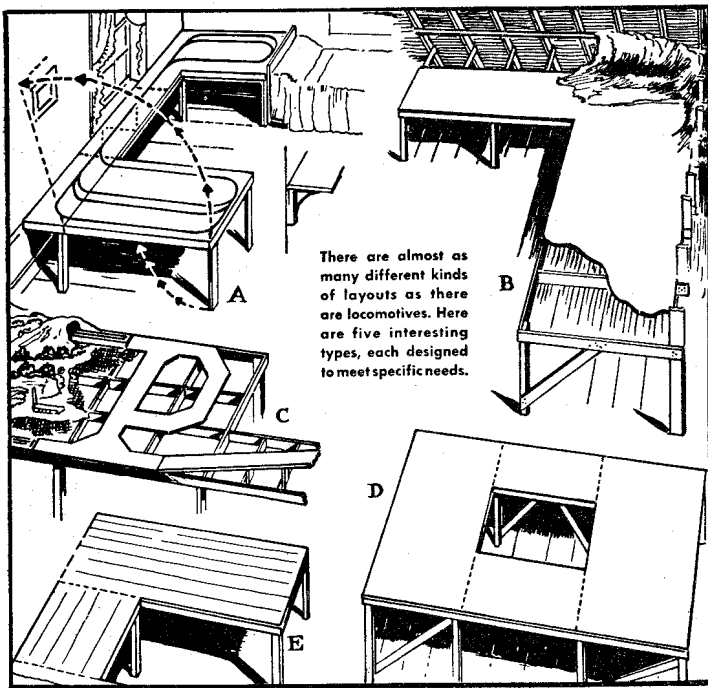

## Realism with Scenery

"Scenery brings it to life." Yes, landscaping is one of the most important parts of building a model pike. General planning of it should take place at the same time you're figuring out your railway system, and some of the actual work must be done before you lay a single section of track. Mountainous areas, rivers, valleys should be in place before track laying is done, so that working on them will not disturb your roadbed. Location of towns will depend on placing of your industrial siding and passenger stations. Keep in mind that you are developing an entire community and countryside. Everything you place in it should have a reason for being where it is. Sketch below shows the first step in landscaping a simple layout.

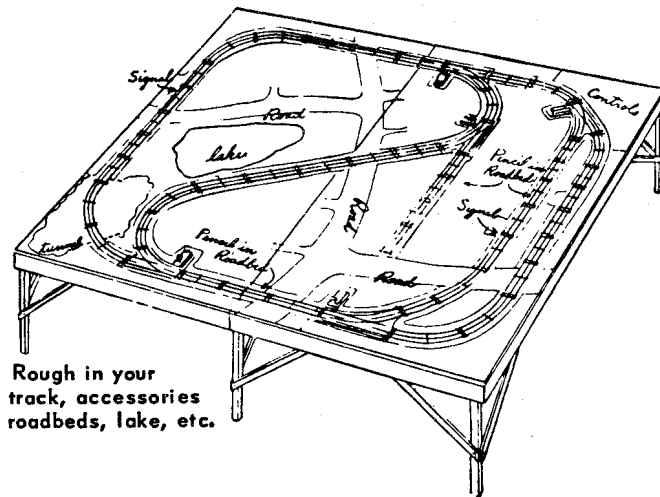

First lay out your track, switches and operating equipment as you plan to have them, without nailing them down. Then, with a pencil, mark off your roadbed with a line about  $\frac{1}{2}$ " outside the ties of the track. Remove track and paint trackbed with thick, grey paint. While paint is still wet sprinkle it with fine ballast stone or sand. After paint has dried, replace track and fasten it down.

The mountain tunnel is built of wood, wire screen and rags. Cut two tunnel portals and wings out of  $\frac{1}{2}$ " pine. After making sure that they give enough clearance for trains, toenail them into position. You can use old window screen for the entire mountain—crumple it up, tack it to portal openings and down to the platform. No other frame is needed, as the wire is stiff enough to hold its shape. If you want to put an accessory on top of the mountain, flatten the wire out for a plateau. Next stretch old rags over the wire, tacking them down on the platform just as you did the wire. Give the whole surface a coat of cheap varnish or shellac and it's finished, ready to paint.

The lake can be made of blue paper and an old piece of glass. Mount the paper on the platform, then touch it up with brown and green crayons to relieve the "flatness" of the blue. Cover the paper with the piece of glass. To cover the edges of the glass make a "rocky" shore of gravel and stones, held together with "Wall Size Glue." This method can also be used to conceal the edges of your mountains, where wire screen and rags have been tacked down.

There's practically no limit to the different materials you can use for plants and shrubs. Some model builders prefer Norwegian Lichen for trees. "Baby's Breath", sold by florists also makes fine trees, after several small branches have been joined together and have been dipped in green paint and sprinkled with sawdust. Sponges make good shrubs and bushes and can be trimmed to almost any shape. They should be well soaked in water before pieces are torn from them, colored green with tintex dye, and glued into place.

Use paint as the base for your flat sections, too. For fields, lawns, etc., brush with green paint and, while still wet, sprinkle with Lionel No. 919 Artificial Grass. For dirt patches, scatter with yellow sand and gravel. Coffee grounds can also be used to simulate cultivated fields. Highways and roads should also be painted, then sprinkled with fine beach sand. For country roads, score lightly to indicate ruts.

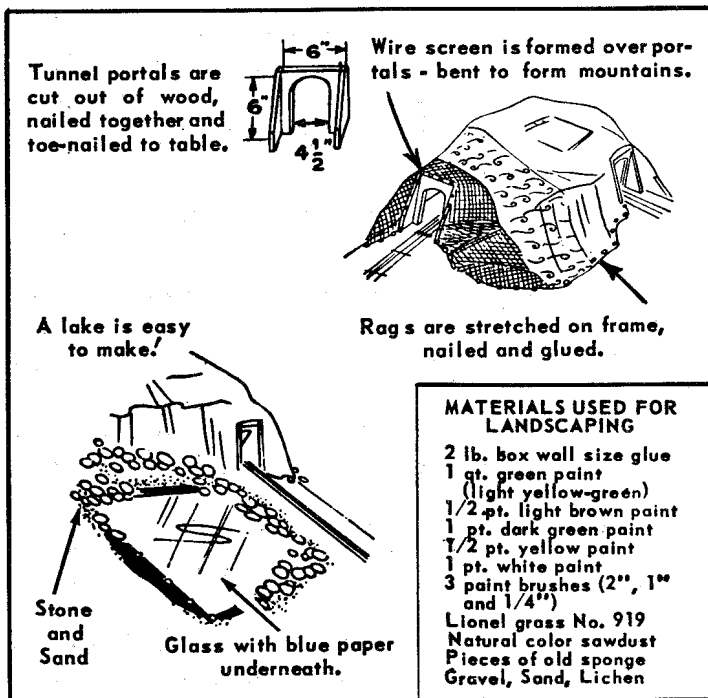

## HOW TO TAKE CARE OF LIONEL EQUIPMENT

Lionel trains and accessories are made of the best available materials and are carefully inspected at every step of production to make sure they reach you in perfect condition. Like all fine mechanical equipment, however, Lionel trains will perform better and last longer if you treat them with proper care.

While complete overhauling and replacement of parts is best done by an Authorized Lionel Repairman, you can do a great deal yourself to keep your trains in good operating order. The most important thing you can do is to clean and lubricate your equipment regularly.

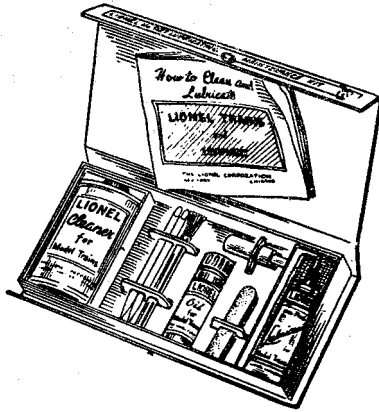

Lionel No. 5159 Lubricating Kit

### Cleaning Your Equipment

All parts of your Lionel outfit which serve as electrical contacting surfaces must be kept clean and free of oil or grease which might act as an insulator. These parts are the rolling surfaces of locomotive and car wheels, the contact rollers and sliders and the track itself. Dampen a clean cloth slightly with Lionel's No. 3927-75 "Track-Clean," run it over the surface to be cleaned, then wipe dry. If the rails

or the rail pins have become rusted, good contacting surface should be restored by polishing with fine sandpaper or emery cloth. *Do not* use steel wool because small metal strands get caught on the track and may cause troublesome short circuits. Loose pins should be tightened with a pair of track pliers described on page 30.

Frequently rails and pins become rust-coated during storage, particularly if they are kept in a damp place. A light coat of lubricant spread on the rails before they are stored away will keep them in good condition and free of rust.

To keep your outfit looking new you may want to clean the cars as well. The painted surfaces of car bodies should be cleaned with a cloth saturated with mild soap suds and dried carefully. Do not use any abrasive cleaners and solvents or you will destroy the car markings.

### Lubricating Lionel Trains

Like all fine mechanical equipment, Lionel Trains should be properly lubricated. This will guarantee good operation and prolong the life of your equipment. Proper lubrication does not mean excessive lubrication. Too much oil or grease is just as bad as none at all, because it will gather dust, foul the motor, and get on the wheels and track making them so slippery that the locomotive will not be able to pull the train. Lubricate thoroughly, but sparingly, and wipe off all excess oil or grease.

### Where Not to Lubricate

Some parts of Lionel equipment should not be lubricated at all because oil or grease would interfere with their operation. These parts are:

- Motor brushes or the commutator surface of motor armatures;
- Track rails or running surfaces of locomotive wheels;
- Conveyor belts carrying artificial coal;
- Contact rollers of locomotives and cars of the type where the roller turns on a rigidly fixed axle.

### Where to Use Oil and Lubricant

A tube of special non-fluid Lionel Lubricant is furnished with each Lionel outfit. Because this grease-type lubricant does not run, it should be used for all exposed moving parts of locomotives and cars. Such exposed parts, marked by letter L in the sketches on these pages, include gears, ends of pilot wheel axles, truck pivots and guides. Pay particular attention to the exposed ends of armature shafts in most steam-type locomotives equipped with transversely mounted motors, such as Nos. 1615, 2018, 646, 2065, etc. Because these shafts rotate at high rates of speed they require lubrication more frequently than any other part of the locomotive. The armature shaft ends can be easily reached with the nozzle of the lubricant tube as shown in sketch at right. Steam locomotives, where the motor is mounted lengthwise, such as No. 736 and No. 746, have large lubricant reservoirs and do not require as much attention.

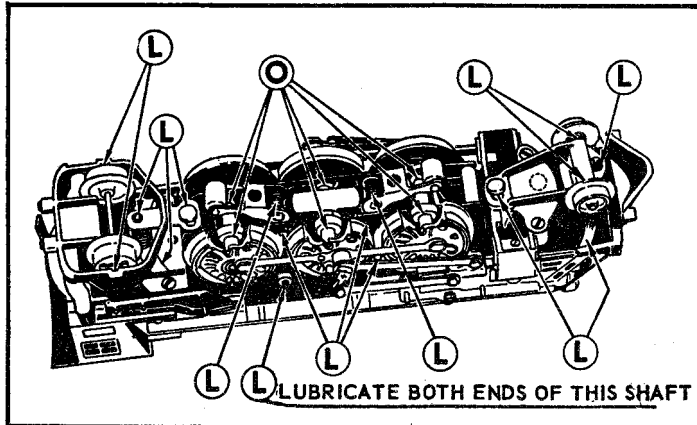

Lubricating Points of a Typical Lionel Locomotive Equipped with a Transversely-Mounted Spur Gear Motor

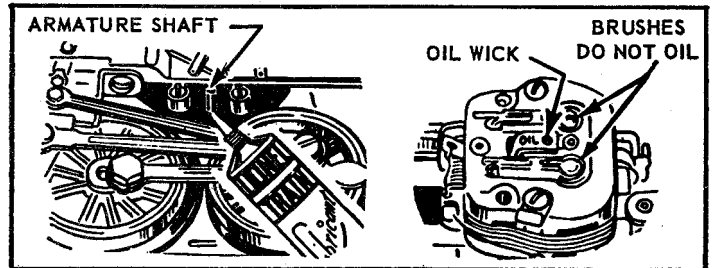

The driving axles of Lionel locomotives run in porous bronze bushings which are impregnated with oil at the Factory and retain their self-lubricating properties for a long time. This self-contained oil supply can be replenished with a few drops of light motor oil. Oil is also used to replenish oil wicks such as are used to lubricate the armature shafts in the motors of most diesel and electric locomotives. Sketch above right shows a type of motor using an oil wick for lubrication. In applying oil be careful not to get any into the brush wells which adjoin the oil hole. To avoid excessive use of oil, and to direct it only at the desired location, the oil should be applied a drop at a time, using a toothpick or a long wire as applicator.

### Lubricating Car Trucks

Improperly lubricated car trucks may double the drag on your locomotive. Spin the wheels by hand. If they show any signs of drag or binding remove the old lubricant and the accumulated dust and dirt with Lionel "Track-Clean", apply a dab of fresh lubricant at ends of axles. (Points "L.")

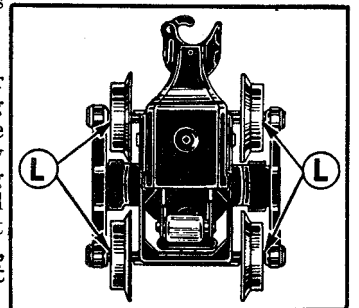

## How to Clean Motors

Sluggish and uneven operation of the locomotive is most often caused by a dirty motor. A typical Lionel motor consists of parts illustrated below. Although these parts may vary somewhat in shape and arrangement they can be easily recognized and are cleaned in the same way. The most important part to be cleaned is the *commutator*, the segmented copper surface on which the carbon *brushes* make their contact. The commutator can be easily seen and reached for cleaning on locomotives having a transversely-mounted motor. To polish the commutator turn the locomotive on its side and connect one wire from transformer to the locomotive contact roller and the other wire to any metal part of the locomotive body. The motor will then run. While it is running press a small piece of very fine sandpaper against the moving commutator. Then clean out the

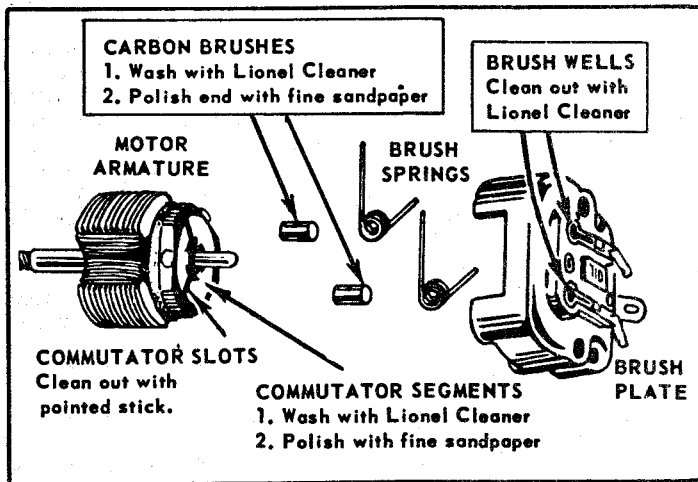

commutator slots with an orange stick, toothpick, or similar pointed wood instrument.

In locomotives where the motor is mounted lengthwise, the motor can be reached only after the locomotive body is removed. In many of them the commutator can be reached through a hole in the brush plate.

## Motor Trouble Shooting

If your train refuses to run, first make sure that the transformer is plugged in and that you are getting current from the transformer output terminals. Then see that all connections on transformers and track are correct and firmly fastened. See that the steel pins inserted at the end of each section of track are clean and tight.

If train still does not run, disconnect the two transformer wires from track. Prop locomotive right side up so that wheels are free to turn. Touch one of these wires to any unpainted part of the motor frame. With the other wire touch the contact shoe which collects the current from the center rail of the track. If motor still does not operate, it may be that the reversing unit is in neutral position. If the E-Unit is in neutral position, the locomotive will not run, although its headlight will be on. Try the above procedure with different adjustments of the reversing unit lever.

If the wheels move very slowly, cleaning and lubricating the motor may be all that is necessary to restore original power.

If motor starts and stops, or if wheels do not revolve, look for loose connections. See if the carbon brushes make good contact with commutator. Clean the commutator as described in a previous section.

If the wheels revolve freely there is nothing wrong with the locomotive motor. The trouble may be that the contact shoe rollers do not have enough tension to make proper contact with the center rail. If contact rollers appear to be badly worn, have them replaced.

## LAMP REPLACEMENT CHART

Cat. No.	Item	Volts	Color	Lamp No.	Price
44 & 45	Mobile Missile Launchers	14	Red	L19(R)	.30
52	Fire Fighting Car	12-16	Clear	L57	.25
68	Executive Car	14	Clear	L19	.25
76	Lamp Post	14	Clear	L19	.25
91	Circuit Breaker	12-16	Clear	L53	.30
112	Super "O" Switch	14	Clear	L19	.25
140	Banjo Signal	12-16	Red	L53(R)	.30
145	Gateman	14	Clear	L363	.30
148	Dwarf Signal	{ 14 14	Red Green	L19(R) L19(G)	.30 .30
151	Semaphore	12-16	Clear	L53	.25
154	Highway Signal	12-16	Red	L53(R)	.30
192	Control Tower	12-16	Clear	L53	.25
195	Floodlight Tower	6	Clear	L12	.20
218	Diesel Locomotive	12-16	Clear	L57	.25
224P-225P	Diesel Locomotives	12-16	Clear	L57	.25
243 & 244	Steam Locomotives	14	Clear	L19	.25
246	Steam Locomotive	6-8	Clear	L51	.20
247	Steam Locomotive	6-8	Clear	L19	.25
252	Crossing Gate	14	Clear	L363	.30
260	Bumper	12-16	Clear	L53	.25
334	Dispatch Board	12-16	Clear	L57	.25
350	Transfer Table	14	Red	L19(R)	.30
350-200	Controller (Trans. Table)	6-8	Clear	L12	.20
353	Control Signal	{ 14 14	Red Green	L19(R) L19(G)	.30 .30
494	Rotating Beacon	14	Clear	L363	.30
614	Diesel Locomotive	12-16	Clear	L53	.25
637	Steam Locomotive	18	Clear	L1445	.30

Cat. No.	Item	Volts	Color	Lamp No.	Price
736	Steam Locomotive	18	Clear	L1447	.35
746	Steam Locomotive	14	Clear	L19	.25
1055	Diesel Locomotive	12-16	Clear	L57	.25
1060	Steam Locomotive	6-8	Clear	L51	.20
1122	"027" Switch	12-16	Clear	L53	.25
1122-100	Switch Controller	12-16	Clear	L53	.25
1862-72	"General" Locomotives	16	Clear	L191	.35
1865-W-6	"General" Passengers	12-16	Clear	L57	.25
2018-37	Steam Locomotives	18	Clear	L1445	.30
2349-58	Diesel Locomotives	12-16	Clear	L57	.25
2383	Diesel Locomotive	18	Clear	L1445	.30
2412-4-6	Passenger Cars	6-8	Clear	L51	.20
2531-2-63	Passenger Cars	12-16	Clear	L57	.25
3435	Aquarium Car	12-16	Clear	L57	.25
3512	Fireman Car	12-16	Clear	L53	.25
3535	Security Car	14	Clear	L363	.30
6357 6427	Caboose	14	Clear	L431	.25
022	"O" Switch	18	Clear	L1445	.30
022C	Switch Controller	{ 18 18	Red Green	L432(R) L432(G)	.35 .35
0145	HO Gateman	12-16	Clear	L53	.25
0181	Cab Control	12-16	Clear	L53	.25
0494	HO Rotating Beacon	16	Clear	L216	.35
0564-5-6-7	HO Diesel Locomotives	14	Clear	L19	.25
0581-91-6-7	HO Diesel Locomotives	14	Clear	L19	.25
0602-5-25	HO Steam Locomotives	16	Clear	L191	.35
0805	HO Atomic Energy Car	14	Red	L19(R)	.30
0834	HO Poultry Car	14	Clear	L19	.25
0880	HO Maintenance Car	12-16	Clear	L53	.25
0056-7-8	HO Diesel Locomotives	16	Clear	L191	.35

Above mentioned prices are subject to change without notice.



# 4' x 8' SUPER "O"

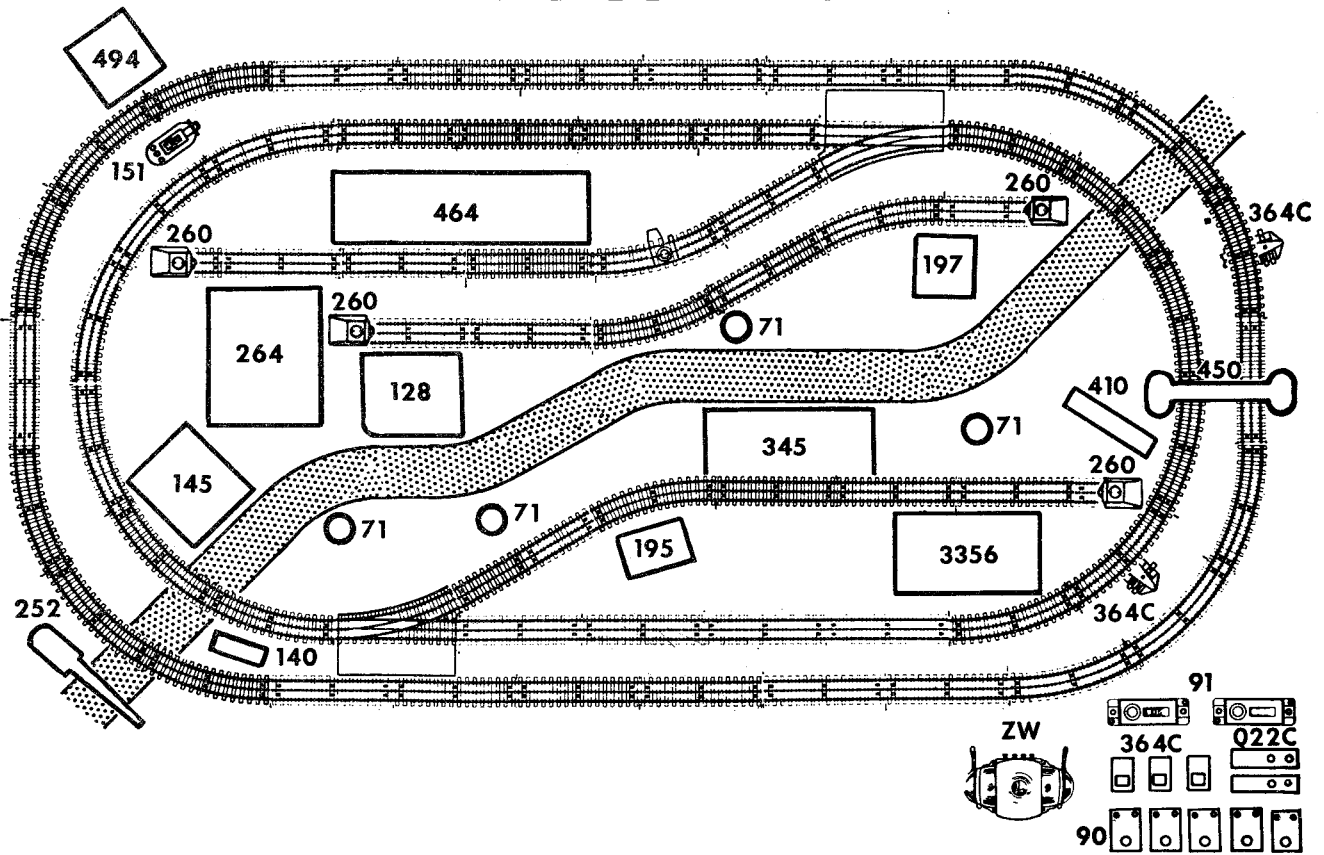

## WIRING DIAGRAM

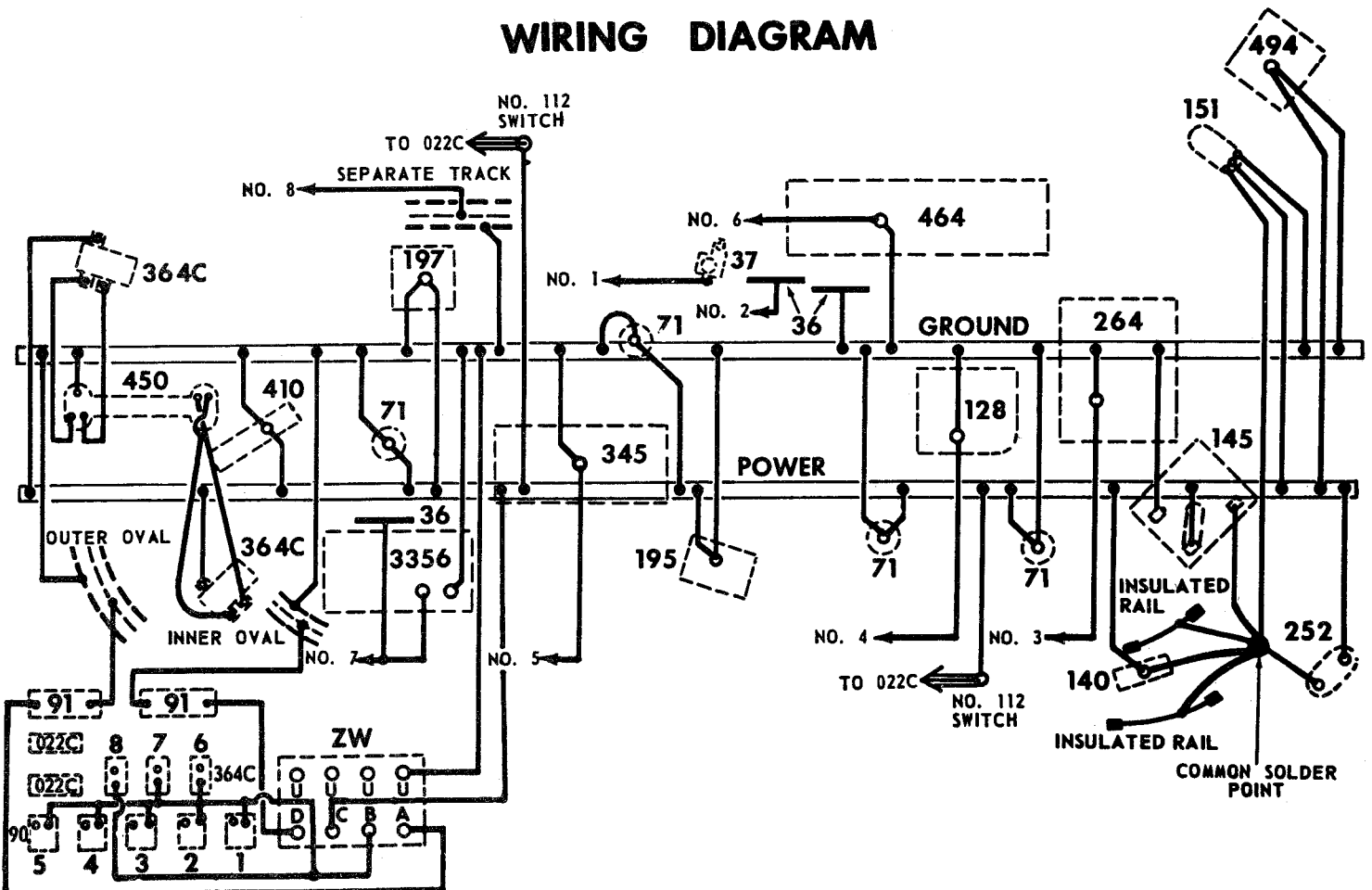

"Wipe Your Track Regularly"

# 5' x 9' SUPER "O"

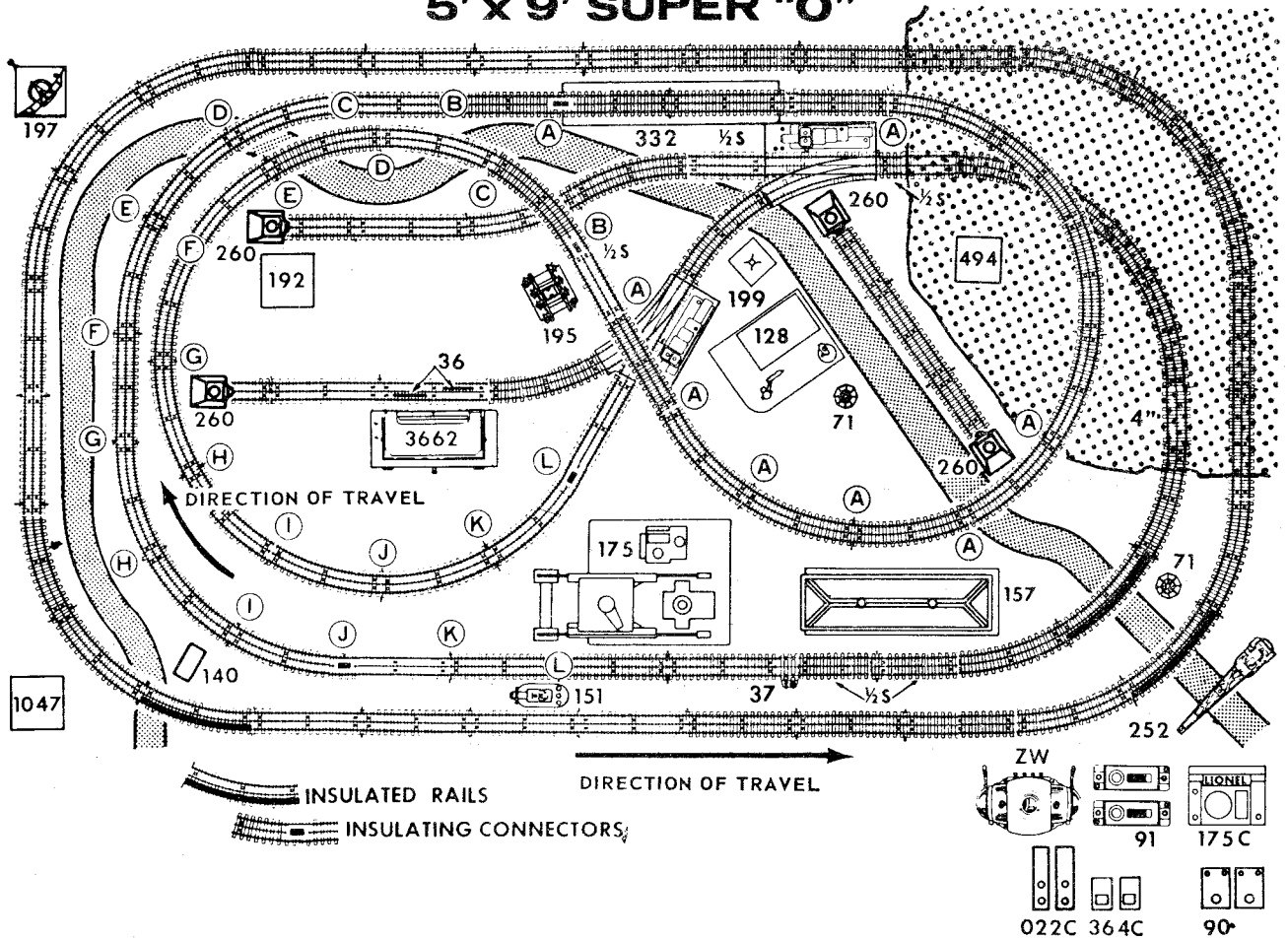

## WIRING DIAGRAM

