

***TMCC***  
***Track Power Controller***  
***300/400 (TPC)***

# Congratulations

**C**ongratulations on your purchase of the TMCC Track Power Controller 300/400 (TPC)! The TPC 300 is capable of distributing up to 300 watts of power for solid state speed control while the TPC 400 brings a whopping 400 watts to your layout! Use the TPC with your Command Base (available separately, 6-12911) and your CAB-1 Remote Controller (available separately, 6-12868) to control any locomotive. Experience the superiority of the Lionel TrainMaster Command Control system!

## Table of contents

---

### ***Wiring Your Track Power Controller***

Powering the Track Power Controller	3-6
Connecting the TPC unit to the track	7
Connecting the COMM wires	8
Connecting additional TMCC products in a “daisy chain”	8
Assigning the TPC unit’s ID#	9

### ***Operating the TPC Unit in the Command environment***

Setting the TPC to operate in the Command environment	10
Turning track power ON in the Command environment	10
Setting the maximum track voltage	11
Turning track power OFF in the Command environment	11
CAB-1 functions in the Command Control Environment	12

### ***Operating the TPC Unit in the conventional (non-Command) environment***

Setting the TPC to operate in the conventional environment	13
CAB-1 Remote Controller functions	14-15
Setting the stall voltage	16

### ***Operating QSI/M.T.H. Proto-Sound features with the TPC unit***

Powering Up	17
Operating QSI/M.T.H. Proto-Sound features with the TPC unit	17-18
Programming your QSI/M.T.H. locomotive	19

### ***Specifications***

Physical	19
Electrical Rating	19
Limited Warranty/Lionel Service	20

The following Lionel marks may be used throughout this instruction manual and are protected under law. All rights reserved.

*Lionel®*, *TrainMaster®*, *Odyssey®*, *RailSounds®*, *CrewTalk™*, *TowerCom™*, *DynaChuff™*, *StationSounds™*, *Pullmor®*, *ElectroCoupler™*, *Magne-Traction®*, *CAB-1® Remote Controller*, *PowerMaster®*, *Lionel ZW®*, *ZW®*, *PowerHouse®*, *TMCC®*, *Lionelville™*, *Lockon®*, *Wireless Tether™*

*The name FasTrack® is used with permission from Pitsco, Inc.*

*M.T.H.®, Proto-Sound®, and Proto-Sound® 2.0 are registered trademarks of M.T.H. Electric Trains®. QSF® is a registered trademark of QSI Industries, Inc.*

# Wiring your Track Power Controller

## Powering the Track Power Controller

The power connections to the TPC unit are located on the back panel. These terminals are labeled HOT and NEUT under POWER IN. Your transformer or PowerHouse Power Supply will power both the TPC unit and the track to which it is connected. Keep in mind that you may power the TPC unit with two transformers if they are phased correctly.

Also, you may choose to power the TPC unit with two TMCC PowerHouse Power Supplies, either the 135 watt version (available separately, 6-12866) or the 180 watt version (available separately, 6-22983). Be sure to purchase the TMCC TPC Cable Set (6-14194) to connect the TPC unit to the PowerHouse Power Supply.

**Caution!** Use at least 14-gauge wire when you are wiring the TPC unit to your transformer! Smaller wire gauges will not be able to handle the current.

### Wiring your TPC unit with a Transformer

1. Attach one wire to the POWER/A terminal on the transformer and connect it to the HOT terminal on the TPC unit.
2. Attach another wire to the COMMON/GROUND/U terminal on the transformer and connect it to the NEUT terminal on the TPC unit.

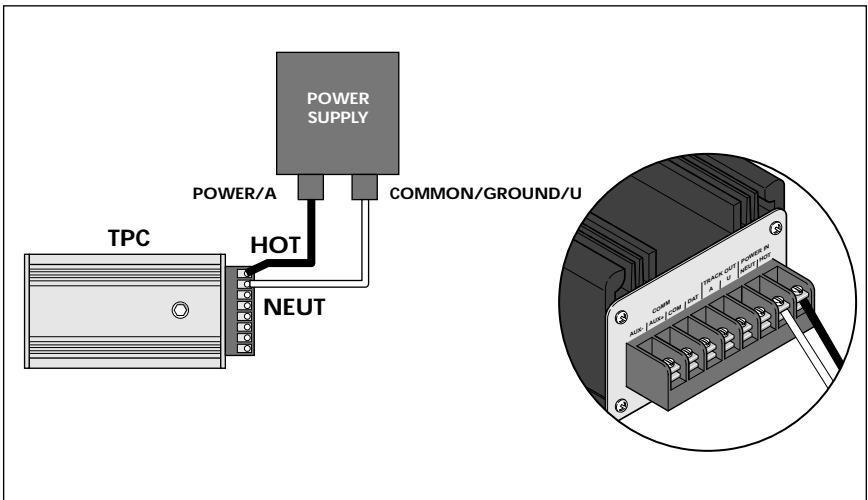

Figure 1. Powering your TPC with a transformer

# Wiring your Track Power Controller

## Powering the Track Power Controller (continued)

### *Wiring your TPC with two power supplies*

1. Plug the two single adapters into the double adapter. The adapters are sold separately in the TPC Cable Set (6-14194).
2. Connect the black wires from the double adapter to the HOT terminal on the TPC unit.
3. Connect the white wires from the double adapter to the NEUT terminal on the TPC unit.
4. On your first power supply, connect one black wire to the Power/A terminal and the white wire to the Common/Ground/U terminal. Be sure that these wires are from the same single adapter.
5. On your second power supply, connect one black wire to the Power/A terminal and the white wire to the Common/Ground/U terminal. Be sure that these wires are from the same single adapter.

**Note!** Be sure to use two of the same power supplies. They must be set to the same output voltages.

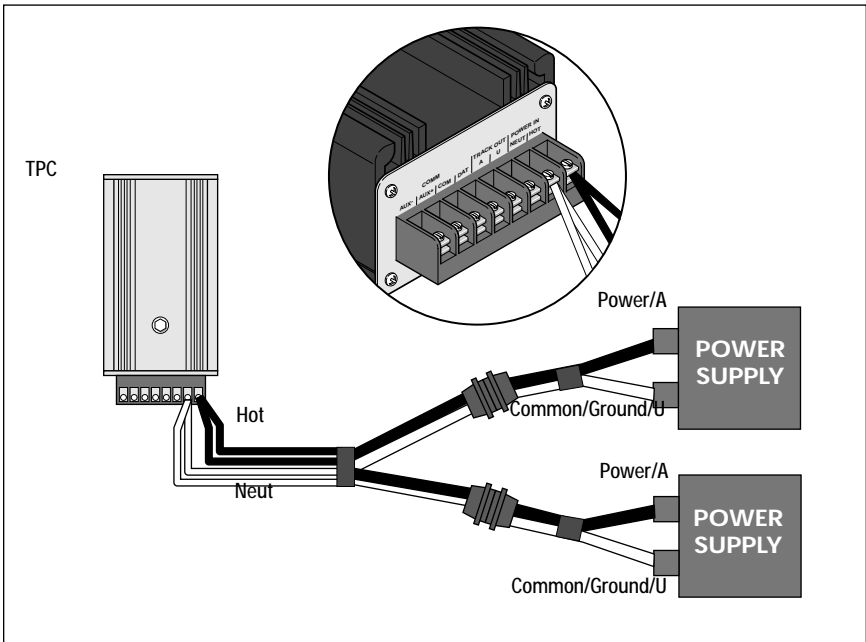

Figure 2. Powering the TPC with two transformers

# Wiring your Track Power Controller

## Powering the Track Power Controller (continued)

### Wiring the TPC unit with a single PowerHouse Power Supply

**Note!** To wire the TPC unit with a single PowerHouse Power Supply, you will need to use the cables with the two adapters from the TMCC TPC Cable Set (available separately, 6-14194).

1. Plug the power output cable on the PowerHouse Power Supply into the adapter on the TMCC TPC Cable.
2. Attach the black wire to the HOT terminal on the TPC unit, located under the POWER IN label.
3. Attach the white wire to the NEUT terminal on the TPC unit.

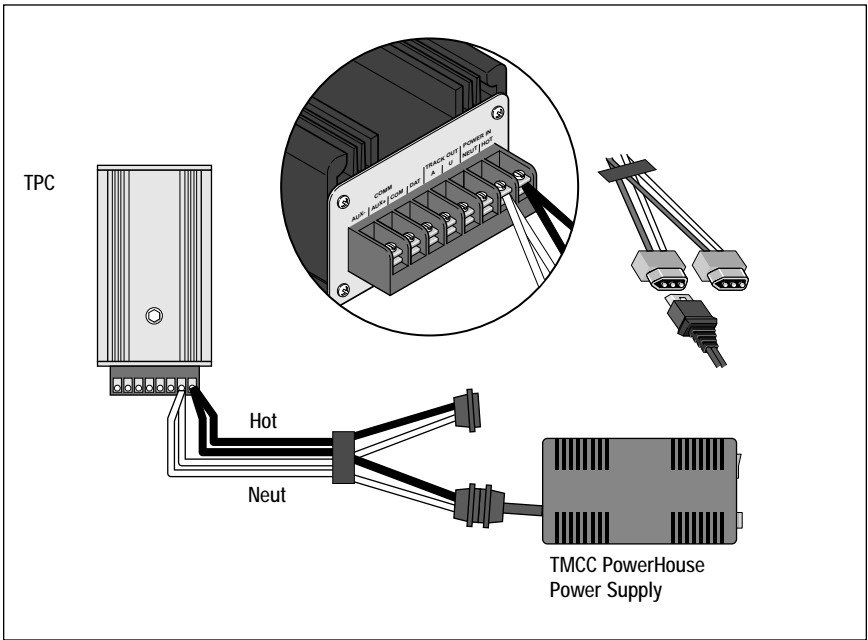

Figure 3. Powering your TPC with a single PowerHouse Power Supply

# Wiring your Track Power Controller

## Powering the Track Power Controller (continued)

**Note!** *Wiring the TPC unit with two PowerHouse Power Supplies*

To wire the TPC unit with two PowerHouse Power Supplies, you will need to use the cable with two adapters from the TMCC TPC Cable Set (available separately, 6-14194).

1. Plug the power output cables on the PowerHouse Power Supplies into the adapters on the TMCC TPC Cable.
2. Attach the black wire to the HOT terminal on the TPC unit, located under the POWER IN label.
3. Attach the white wire to the NEUT terminal on the TPC unit.

**Note!** Wire similar PowerHouse Power Supplies only. Do not wire a 135-watt PowerHouse Power Supply with a 180-watt PowerHouse Power Supply.

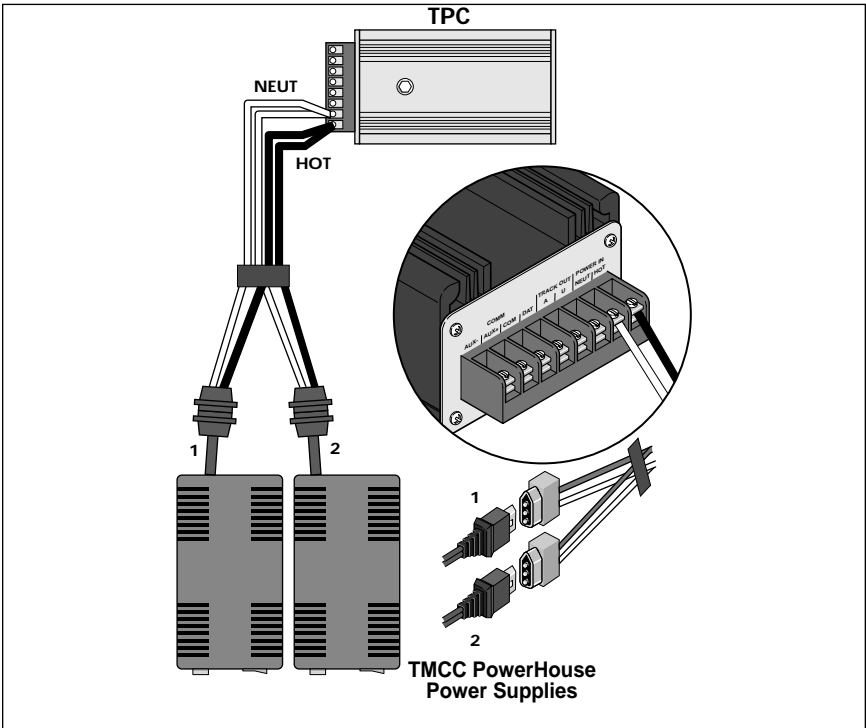

Figure 4. Powering your TPC with two PowerHouse Power Supplies

# Wiring your Track Power Controller

## Connecting the TPC unit to the track

Use the terminals labeled TRACK OUT to connect the TPC unit to the track. If you are using Lionel O-27 or O gauge track, be sure to purchase a Lionel Lockon (6-62900). Follow these steps and refer to Figure 5 as you connect your TPC to the track.

**Caution!** Use at least 14-gauge wire when you are wiring the TPC unit to the track! Smaller wire gauges will not be able to safely handle the current.

1. Attach a Lionel Lockon (available separately, 6-62900) to the track.

Slide the bottom edge of the outside rail into the metal lip on the Lockon. Press the clip at the end of the Lockon over the bottom edge of the inside rail.

2. Attach one wire to the #1 spring clip terminal on the Lionel Lockon (or to the center rail) and connect it to the TRACK OUT terminal labeled A on the TPC unit.

*Spring clip terminal connections:* Press down on the top of the terminal clip so that a metal loop is formed. Slide the bare end of the wire into the exposed loop. Release pressure on the terminal clip, allowing the crimped metal to pinch the end of the wire in the metal loop. Give a little tug on the wire to check if the hold is secure.

3. Attach one wire to the #2 spring clip terminal on the Lionel Lockon (or to the outside rail) and connect it to the TRACK OUT terminal labeled U on the TPC unit.
4. Attach one wire to the U terminal on the Command Base and connect it to the #2 Lockon terminal (or to the outside rail).

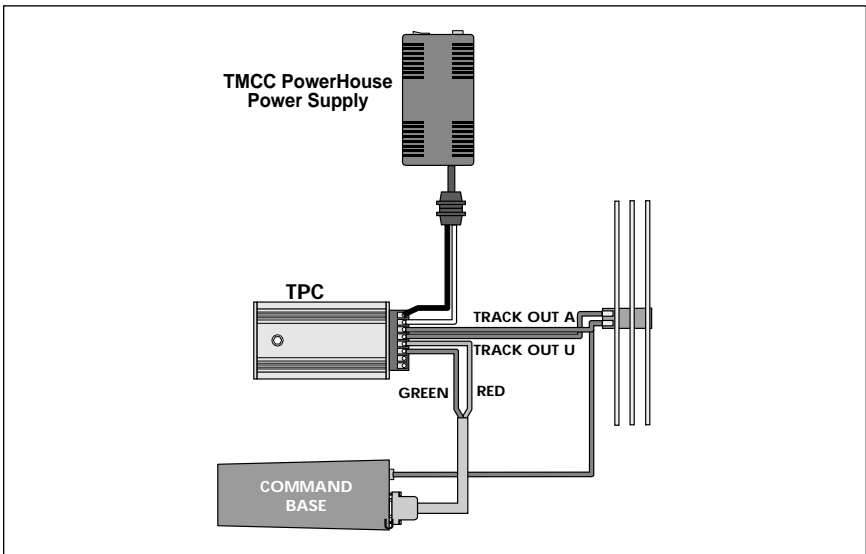

Figure 5. Track connections

# Wiring your Track Power Controller

## Connecting the COMM wires

---

**Y**our TPC unit will need to communicate with the Command Base and any other TMCC products you have connected to your TPC unit. To make these connections, you will need the Command Base Cable (available separately, 6-14191 for a 6' cable and 6-14195 for a 20' cable). Follow these steps and refer to Figure 5 on page 7 to connect your TPC unit to the Command Base.

**Note!** Your TPC is equipped with two additional COMM terminals, AX+ and AX-. They are intended for future capabilities. At this time, leave these terminals empty. Do not connect the DAT and COMM wires to AX+ and AX- terminals.

1. Connect the DB9 Connector at the end of the Command Base Cable (the end that looks like a computer cable) to the COMPUTER terminal on the Command Base.
2. Connect the red wire at the other end of the Command Base Cable to the DAT terminal on the TPC unit.
3. Connect the green wire of the Command Base Cable to the COM terminal on the TPC unit.

## Connecting additional TMCC products in a “daisy chain”

---

**Y**ou may choose to power additional TMCC products using the same power supply and Command Base by creating a “daisy chain,” or a series of TMCC units wired in succession. To make these connections, we recommend that you purchase a Controller to Controller Cable, available separately in various lengths.

### *COMM connections for additional units*

Attach a red wire to the DAT terminal of the TPC unit and connect it to the DAT terminal of the next TMCC product. Attach a green wire to the COM terminal of your TPC unit and connect it to the COM terminal of the next product. Add additional products in the same manner, connecting the DAT terminals and the COM terminals.

**Note!** For maximum power output, each TPC should use its own power supply.



# Wiring your Track Power Controller

## Assigning the TPC unit's ID#

To address and operate the TPC with your CAB-1 Remote Controller, you must assign an ID# to the TPC unit. The TPC unit can be assigned a TR (track/train) or an ENG (engine) ID#. Keep in mind that there are ten TR ID#'s (0-9) and 100 ENG ID#'s (0-99).

1. Set the RUN/PRG switch to PRG on the TPC.

Refer to Figure 6 for the location of the switch.

2. Press **TR** or **ENG** on the CAB-1 Remote Controller.
3. Enter the ID# of your choice (**0-9** for **TR** ID#'s or **0-99** for **ENG** ID#'s) into the numeric keypad of the CAB-1 Remote Controller.
4. Press **SET** on the CAB-1 Remote Controller.

**LED** The COMM L.E.D. will flash for half of a second to indicate that the TPC has been set.

5. Slide the switch back to RUN.

At this point, the ID# of the TPC unit has been set.

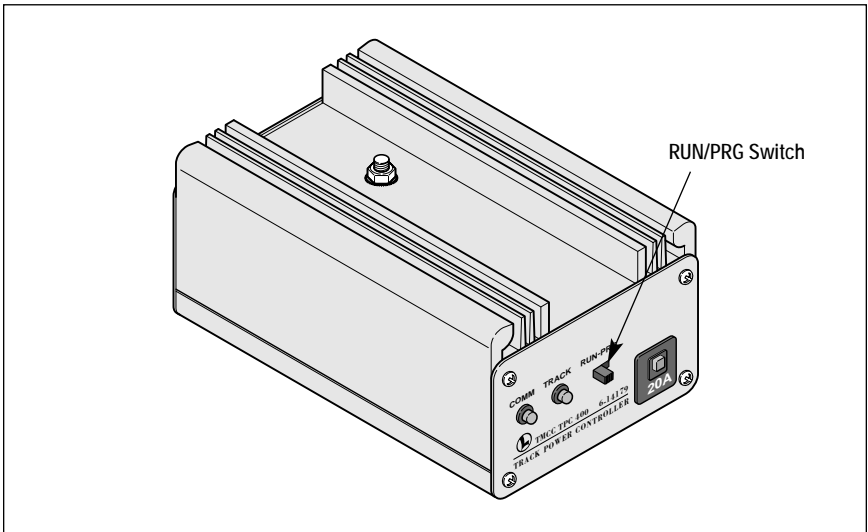

Figure 6. Switch location

# ***Operating the TPC Unit in the Command environment***

**O**perate your TPC unit in Command mode when your locomotives are equipped with TrainMaster Command Control. In the Command Control environment, the locomotives receive signals from the Command Base that tell the locomotive what to do. Because speed and direction are not controlled by track voltage, use the TPC to set the maximum power that will be supplied at all times.

## **Setting the TPC to operate in the Command environment**

Before you use the TPC unit in the Command environment, you must set the TPC unit to Command mode.

1. Press **TR** or **ENG** on the CAB-1 Remote Controller.
2. Enter the ID# of the TPC unit into the numeric keypad on the CAB-1 Remote Controller.
3. Press the **L** button on the bottom of the CAB-1 Remote Controller.

**LED** The TRACK L.E.D. will flash slowly to indicate that the TPC is in Command mode. When power is supplied to the track, the TRACK L.E.D. will blink quickly.

4. Press the **SET** button on the CAB-1 Remote Controller to save this mode.

**LED** The COMM L.E.D. will long blink to indicate that the TPC has been set.

The TPC will remain in Command mode, even after the power is turned off.

**Note!** The TPC will turn OFF when changing between conventional and Command operations.

## **Turning track power ON in the Command environment**

You must use your CAB-1 Remote Controller to turn track power ON with the TPC unit.

1. Press the **TR** or **ENG** button on the CAB-1 Remote Controller.
2. Enter the ID# of the TPC unit into the numeric keypad on the CAB-1 Remote Controller.
3. Press the **BOOST** button on the CAB-1 Remote Controller.

**LED** The TRACK L.E.D. will blink quickly to indicate that the track is powered up.

At this point, full track voltage is applied to the track.

# *Operating the TPC Unit in the Command environment*

## **Setting the maximum track voltage**

---

While track voltage is not used to control the speed of your locomotives in Command Control, you may choose to adjust the track voltage to adjust the maximum power available to your locomotives.

1. Address the TPC. Press the **TR** or **ENG** button on the CAB-1 Remote Controller, then enter the ID# of the TPC.
2. Adjust the track voltage. Use the **RED KNOB** on the CAB-1 Remote Controller to increase the track voltage with a clockwise turn; decrease track voltage with a counter-clockwise turn.
3. With the TPC unit's RUN/PROG switch set to RUN, press **SET** on the CAB-1 Remote Controller. You have set the default voltage. Each time the TPC is powered up, the track voltage will be set to this level.

To restore the track voltage to the default (full power), simply press **AUX1**, **AUX2**, then **0**. You may also turn the **RED KNOB** to restore power.

## **Turning track power OFF in the Command environment**

---

You must use your CAB-1 Remote Controller to turn track power OFF with the TPC unit.

1. Press the **TR** or **ENG** button on the CAB-1 Remote Controller.
2. Enter the ID# of the TPC unit into the numeric keypad on the CAB-1 Remote Controller.
3. Press the **AUX1** button on the CAB-1 Remote Controller.
4. Enter **0** into the numeric keypad on the CAB-1 Remote Controller.

**LED** The TRACK L.E.D. will blink slowly to indicate that track power is OFF.

At this point, track power is shut off.

# Operating the TPC Unit in the Command environment

## CAB-1 Remote Controller functions in the Command Control environment

Use the following CAB-1 Remote Controller commands in the Command Control environment.



Adjusts track voltage level.



Turns track power ON. Use AUX1, 0 command to turn track power OFF.



Places the TPC in Command mode with power OFF.



Places the TPC in conventional mode with power OFF.



Turns off track power.



Sets the number of throttle increments to 80 speed steps. Coarse resolution in intervals of speed.



Sets the number of throttle increments to 200 speed steps. Medium resolution in intervals of speed.



Sets the number of throttle increments to 400 speed steps. Fine resolution in intervals of speed.



Saves current track voltage and speed resolution as power-up defaults when the RUN/PRG switch is set to RUN. Assigns the TPC ID# when the RUN/PRG switch is set to PRG.



Resets the TPC to factory defaults.



# ***Operating the TPC Unit in the conventional (non-Command) environment***

**O**perate your TPC unit in conventional mode when your locomotive is not equipped with TrainMaster Command Control. Conventional locomotives operate by varying the voltage to the track. For example, a conventional locomotive will increase in speed as track voltage increases. The TPC unit will allow you to operate your conventional locomotives by remote control, varying the voltage supplied to the track.

**Note!** All conventional locomotives on the same loop or block of track will be controlled together.

**LED** The TRACK L.E.D. will increase in intensity as track voltage increases. If it blinks, you are not in conventional mode. See below.

## **Setting the TPC to operate in the conventional environment**

Before you use the TPC unit in the conventional (non-Command) environment, you must set the TPC unit to conventional mode.

1. Press **TR** or **ENG** on the CAB-1 Remote Controller.
2. Enter the ID# of the TPC unit into the numeric keypad on the CAB-1 Remote Controller.
3. Press the **M** button on the bottom of the CAB-1 Remote Controller.

**LED** The TRACK L.E.D. will turn OFF to indicate that the TPC is in conventional mode without power.

4. Press the **SET** button on the CAB-1 Remote Controller.

**LED** The COMM L.E.D. will long blink to indicate that the TPC has been set.

The TPC will remain in conventional mode, even after the power is turned off.

**Note!** The TPC will turn OFF when changing modes.

# Operating the TPC Unit in the conventional (non-Command) environment

## CAB-1 Remote Controller functions

Use the following CAB-1 Remote Controller commands to control your locomotive in conventional mode.



Turn clockwise to increase the speed of the locomotive; turn counter-clockwise to decrease the speed.



Press and hold to increase the speed of the locomotive; release to return speed to the initial setting plus one step. Tap BOOST to increase one step for fine control.



Press and hold to decrease the speed of the locomotive; release to return speed to the initial setting minus one step. Tap BRAKE to decrease one step for fine control.



Sounds the whistle or horn on the locomotive.



Activates the bell.



Controls the direction of the train. Removes track power when pressed; restores track power when released.



Activates the numeric keypad.



Acts like the shift key on your computer. Allows the buttons to have another function.



Opens the front coupler (M.T.H.® Proto-Sound® 2.0 engines).



Opens the rear coupler (M.T.H.® Proto-Sound® 2.0 engines).



Saves current settings to be restored upon next power-up when the RUN/PRG switch is set to RUN. Assigns the TPC ID# when the RUN/PRG switch is set to PRG.



Sets TPC to Command mode with power OFF.



Sets the TPC to conventional operation with power OFF.



Sets the maximum speed limit in conventional mode. Use the red knob to set the throttle at your desired maximum speed, then press H.



# Operating the TPC Unit in the conventional (non-Command) environment

## CAB-1 Remote Controller functions (continued)

---



Turns track power off.



Sets the stall (minimum) voltage.



Places track voltage to the current stall voltage (set with AUX1, 1).



Sets the number of throttle increments to 80 speed steps.



Sets the number of throttle increments to 200 speed steps.



Sets the number of throttle increments to 400 speed steps.



Resets the TPC to factory defaults.

# *Operating the TPC Unit in the conventional (non-Command) environment*

## **Setting the stall voltage**

---

**Y**ou can set the TPC stall voltage with your CAB-1 Remote Controller. Setting the stall voltage locks the minimum voltage. Once set, you will not be able to lower the voltage any lower than this level. This is especially useful when operating locomotives with E-units. Because you can set the minimum voltage, you can prevent the E-unit from resetting itself due to a complete loss of power.

**Note!** To completely remove the voltage from the track, press the **AUX1, 0** on the CAB-1 Remote Controller.

1. Use the **RED KNOB** on the CAB-1 Remote Controller to increase the voltage to your desired minimum voltage.
2. Press **AUX1, 1** on the numeric keypad when you have reached the desired minimum voltage.
3. Press **SET** if you wish to save the minimum voltage for the next time you power up the TPC.

**LED** The COMM L.E.D. will long blink to indicate that the TPC has been set.

**Note!** To reset the stall voltage back to zero, press the **AUX1, AUX2, 0** on the CAB-1 Remote Controller. This will reset ALL conventional settings. If you wish to save the settings, press the **SET** button on the CAB-1 Remote Controller.

Press **AUX1, 4** to set the track voltage to the current stall voltage.

**Note!** This is a quick way to turn down the voltage to the current stall setting.



## Operating QSI®/M.T.H.® Proto-Sound® features with the TPC unit

**A**dditional features have been added to the TPC unit to unlock the operation of the QSI®/M.T.H.® E units. The TPC unit makes M.T.H.® products operating in conventional mode compatible with the Lionel TrainMaster Command Control system!

### Powering up

---

**U**se your CAB-1 Remote Controller to power up the the track and control an M.T.H.® Proto-Sound® 1.0 locomotive.

1. Press **TR** or **ENG** on the CAB-1 Remote Controller.
2. Enter the ID# of the TPC unit into the numeric keypad on the CAB-1 Remote Controller.
3. Press **AUX1, 9** on the CAB-1 Remote Controller.

The power up sequence has been activated.

**Caution!** Do not press the **DIR** button; full power is applied to the track at this point.

4. After the engine sounds begin (or five seconds), enter the track voltage setting. Press **8** to supply 30% of full power.

**Note!** If you do not enter this number, your locomotive will take off as soon as you press the **DIR** button on the CAB-1 Remote Controller! If you accidentally start up the locomotive without selecting a voltage level (step 4), simply turn the power off and restart using this sequence.

5. Move 'em out! Press the **DIR** button on the CAB-1 Remote Controller.

### Operating M.T.H.® Proto-Sound® features with the TPC unit



















---













**T**he TPC allows you to operate M.T.H.® Proto-Sound® 2.0 locomotives in conventional mode. At the press of a few buttons, your favorite conventional Proto-Sound® 2.0 features—like speed control and coupler operation—are at your command.





**Note!** All M.T.H.® Proto-Sound® 2.0 features can be accessed in conventional mode. Refer to the next section for additional information.



# Operating QSI®/M.T.H.® Proto-Sound® features with the TPC unit

## Operating M.T.H.® Proto-Sound® features with the TPC unit (continued)

-   Turns track power off.  
(used with Proto-Sound® 1.0 and 2.0)
-   M.T.H.® Sets the minimum voltage.  
(used with Proto-Sound® 1.0)
-   M.T.H.® Station Talk.  
(used with Proto-Sound® 2.0)
-   M.T.H.® Fast Horn.  
(used with Proto-Sound® 2.0)
-   Places track voltage to the current stall voltage  
(set with AUX1, 1). (used with all)
-   M.T.H.® Programming Pulse.  
(used with Proto-Sound® 1.0)
-   M.T.H.® Fast Bell.  
(used with Proto-Sound® 2.0)
-   Places track voltage at 30% of input.  
(used with Proto-Sound® 1.0)
-   Places full voltage on the track. Start up  
sequence for M.T.H.® Proto-Sound®1.0.

-    Resets the TPC to factory defaults.
-    M.T.H.® Speed control toggle ON/OFF.  
(used with Proto-Sound® 2.0)
-    M.T.H.® Reset to factory defaults.  
(used with Proto-Sound® 2.0)
-    M.T.H.® Lock direction toggle ON/OFF.  
(used with Proto-Sound® 2.0)

-   Sets the number of throttle increments to 80 speed steps.
-   Sets the number of throttle increments to 200 speed steps.

-   Sets the number of throttle increments to 400 speed steps.

-  M.T.H.® Opens front coupler.  
(used with Proto-Sound® 2.0)
-  M.T.H.® Opens rear coupler.  
(used with Proto-Sound® 2.0)

-  Saves current track voltage and speed resolution as power-up defaults when the RUN/PRG switch is set to RUN. Assigns the TPC ID# when the RUN/PRG switch is set to PRG.



# *Operating QSI®/M.T.H.® Proto-Sound® features with the TPC unit*

## **Programming your QSI®/M.T.H.® locomotive**

---

**T**he TPC allows you to program your QSI®/M.T.H.® locomotives with ease, bringing some of the Proto-Sound® features under your control while operating in conventional mode. Follow these steps and refer to your locomotive's instructions for information about your engine's features.

1. Press **M** on the CAB-1 Remote Controller. Be sure to wait for the sounds to stop completely. This will reset the engine by completely removing power.
2. Press **AUX1, 9** on the CAB-1 Remote Controller. Track voltage goes to full.
3. Press **5** repeatedly on the numeric keypad until the desired feature is activated. A programming pulse is sent through the track to program the QSI®/M.T.H.® units.

**Note!** Do not press the **AUX1** button on your CAB-1 Remote Controller between pressing **9** and **5**.

4. Press the **WHISTLE** button on the CAB-1 Remote Controller to program that feature. Consult your M.T.H.® engine operating instructions for specific details.

## ***Specifications***

### **Physical**

---

Size: 6.125" x 3.75" x 2.7"

### **Electrical Ratings**

---

Maximum input voltage: 9 to 30 volts (AC) at 50 or 60 Hz

COMM input signal: +/- 12 volts

Maximum output current: 15 amps at 20 volts or 300 watts (TPC 300)  
20 amps at 20 volts or 400 watts (TPC 400)

## Limited Warranty/Lionel Service

---

**T**his Lionel product, including all mechanical and electrical components, moving parts, motors and structural components, except for light bulbs, is warranted to the original consumer-purchaser, for **one year** against original defects in materials or workmanship when purchased through an authorized Lionel merchant.

This warranty does NOT cover normal wear and tear, light bulbs, defects appearing in the course of commercial use, or damage resulting from abuse or misuse of the product by the purchaser. Transfer of this product by the original consumer-purchaser to another person voids this warranty. Modification of this product voids this warranty.

Any warranted product which is defective in original materials or workmanship and is delivered by the original consumer-purchaser to Lionel L.L.C. or an authorized Lionel L.L.C. Service Center, together with proof of original purchase will, at the option of Lionel L.L.C., be repaired or replaced, without charge for parts or labor. In the event the defective product cannot be repaired, and a replacement is not available, a refund of the original purchase price will be granted. Any products on which warranty service is sought must be sent freight or postage prepaid, as transportation and shipping charges are not covered by the warranty.

### **In no event shall Lionel L.L.C. be liable for incidental or consequential damages.**

Some states do not allow the exclusion or limitation of incidental or consequential damages, so the above exclusion may not apply to you.

This limited warranty gives you specific legal rights, and you may have other rights which vary from state to state.

### **Instructions for Obtaining Service**

If service for this Lionel L.L.C. product is required, bring the item, along with your dated sales receipt and completed warranty information to the nearest Authorized Lionel Service Center. Your nearest Lionel Service Center can be found by calling 1-800-4-Lionel, or by accessing our Website at [www.lionel.com](http://www.lionel.com).

If you prefer to send your product back to Lionel L.L.C. for repair in Michigan, you must first call 586-949-4100 or FAX 586-949-5429, or write to Customer Service, P.O. Box 748, New Baltimore, MI 48047-0748, stating what the item is, when it was purchased and what seems to be the problem. You will be sent a return authorization letter and label to ensure your merchandise will be properly handled upon receipt.

Once you have received your return authorization and label, make sure that the item is packed to prevent damage during shipping and handling. We suggest that you use the product's original packaging. This shipment must be prepaid and we recommend that it be insured.

Please make sure you have followed all of the above instructions carefully before returning any merchandise for service. You may choose to have your product repaired by one of our Authorized Lionel Service Centers after its warranty has expired. A reasonable service fee will be charged.

### **Warranty Information**

Please complete the information below and keep it, along with your dated sales receipt. You must present this and your dated sales receipt when requesting warranty service.

Name \_\_\_\_\_

Address \_\_\_\_\_

Place of Purchase \_\_\_\_\_

Date of Purchase \_\_\_\_\_

Product Number \_\_\_\_\_

Product Description \_\_\_\_\_



©2004 LIONEL L.L.C., CHESTERFIELD, MI 48051-2493  
UNITED STATES OF AMERICA  
PRINTED IN CHINA