

how to Operate



# LIONEL TRAINS

1954

and Accessories



## IMPORTANT—READ THIS FIRST

### **Never Connect Your Layout Directly to a Household Electric Outlet. Always Use a Transformer.**

Most Lionel train outfits are designed for use with Lionel "Multi-Control" transformers. These transformers change the line voltage available in your house to low voltage suitable for Lionel trains and accessories. "Multi-Control" transformers are equipped with built-in controls for regulating train speed, stopping and reversing locomotives, and blowing the train whistle.

All "027" outfits include a transformer which is suitable for operating the train plus a few lights or signals.

"0" outfits DO NOT include a transformer. A transformer to fit the requirements of your model railroad must be purchased separately from your dealer.

### **Make Sure That Your Transformer Rating (Volts and Cycles) Corresponds to Your House Electric Supply.**

Most places in the United States use 110-115 volt, 60-cycle

current, but there are a number of exceptions. In areas where special conditions exist special transformers for these are available from your Lionel dealer. If you are in doubt about the rating of your household supply, consult your electric company.

### **If You Happen to Have Direct Current (D.C.), a Transformer Cannot Be Used.**

Low voltage direct current such as is available from automobile storage batteries, or from d.c. generators used in some rural areas can be used with special control units instead of transformers.

High voltage direct current such as is used in some lower Manhattan areas in New York City requires the use of an INVERTER in addition to the transformer. See the section "Your Power Supply." For more information about d.c. operation write to Lionel Engineering Department.

## HOW TO USE THIS BOOKLET

We know that most people don't like to read instruction books, but model railroading can become pretty complicated unless you know something about it. This booklet is designed both for the beginner and for the advanced model railroader.

If you are a beginner we suggest you read the first part of the book carefully. It will tell you step by step how to set up and operate a simple one-train layout.

You can glance over the rest of the book just to see what it contains so that you can refer to it if you run into trouble or want further information.

If you want to know more about this fascinating hobby, read "Model Railroading" written by Lionel editorial staff and published by Bentam Books. You can get it for 50 cents at most local newsdealers or from the Lionel Advertising Department.

All Contents Copyrighted 1954 by

THE LIONEL CORPORATION

15 East 26th Street, New York 10, N. Y.

# TABLE OF CONTENTS

## PART ONE

### How to Operate Your First Lionel Outfit

#### HOW TO ASSEMBLE YOUR LAYOUT Page 2

Check Your Equipment — Join the Track Sections — Attach Lockon to Track — Connect Lockon to Transformer — Which Transformer Posts to Use — Short Circuits — Checking Trouble Spots

#### HOW TO OPERATE THE TRAIN Page 6

Regulating Train Speed — Reversing the Locomotive — How to Disconnect Reversing Mechanism — Sounding the Whistle or Horn — Operation of the Horn — "Magne-Traction" Locomotives — Lionel "Smoke" Locomotives — How to Take Care of Smoke Locomotives — Coupling and Uncoupling

#### AUTOMATIC OPERATING CARS Page 9

Cars Using Contact Sliders — Plunger-Operated Cars — No. 352 Operating Barrel Car — No. 3614 Operating Stock Car

## PART TWO

### Model Railroad Accessory Equipment

#### TABLE OF ACCESSORY CONNECTIONS Page 12

What Voltages to Use — How to Connect Accessories in "Parallel"

#### AUTOMATIC SIGNALING Page 14

Installing 145C and 159C Contactors — No. 140 Banjo Signal — No. 145 Galeman — No. 151 Semaphore — No. 153 Block Signal — No. 445 Switch Tower — No. 252 Crossing Gate — No. 450 Signal Bridge — No. 154 Crossing Signal — No. 125 Whistle Station

#### OPERATING ACCESSORIES Page 20

No. 356 Freight Station — No. 455 Oil Derrick — No. 132 Automatic Passenger Station — No. 364 Lumber Loader — No. 397 Coal Loader — No. 362 Barrel Loader — No. 282 Gantry Crane — No. 456 Coal Ramp Set — No. 497 Coal Station

#### SWITCHES AND CROSSINGS Page 26

No. 022 Switches — Other Uses of Non-Derailing Mechanism — Controlling Signals with Non-Derailing Mechanism — No. 1122 Switches for "027" Track — Use of Crossings

#### MULTIPLE TRAIN OPERATION Page 29

One Loop with Insulated Blocks — Preserving Reversing with Insulated Blocks — Separate Insulated Loops — Typical Layouts for Multiple Train Operation — Use of Relays

#### WORKING WITH LIONEL TRACK Page 36

Lionel Track Sizes — How to Make Shorter Sections — Lionel Track Filters — Insulated Track Sections — Automatic Control of Accessories — Automatic Control of Trains

#### SPECIAL INSTALLATIONS AND CONTROLS Page 40

Fixed Voltage for Remote Control Sections — Use of No. 167 Whistle Controller

#### ABOUT YOUR POWER SUPPLY Page 41

Alternating and Direct Current — What a Transformer Does — What Causes Voltage Drop — Using Auxiliary Lockons — Circuits with Common "Ground" — Transformer Rating — About Wattage — Power Requirements of Lionel Equipment — How to Estimate Available Power — How to Connect Transformers in "Parallel"

## PART THREE

### How to Build a Model Railroad

#### HOW TO PLAN AND BUILD A MODEL RAILROAD Page 46

Planning the Layout — How to Build Platforms — Building Grades — Achieving Realism by Landscaping — Running a Railroad

## PART FOUR

### How to Take Care of Lionel Equipment

#### WHAT YOU CAN DO YOURSELF Page 51

Cleaning Your Equipment — Lubricating Lionel Trains — Where Not to Lubricate — Where to Use Lionel Lubricant — Where to Use Oil — Lubricating Car Trucks — The Train Whistle — Replacing Headlight Lamps — How to Clean Motors — Motor Trouble Shooting

#### LIONEL AUTHORIZED SERVICE STATIONS Page 55



## HOW TO ASSEMBLE AND OPERATE YOUR FIRST LIONEL OUTFIT

### Check Your Equipment

By the time you read this you have probably already unpacked and examined your Lionel outfit. It's a good idea to save the boxes and the corrugated board packing. They have been carefully designed to protect the equipment and will come in handy for storing or transporting your outfit.

Check your equipment to see that nothing is missing.

A standard Lionel train outfit includes the following:

- Locomotive (either steam-type or diesel)
- Locomotive tender (with steam-type locomotives)
- 3 to 5 cars (either freight or passenger)
- 8 sections of curved track
- 1 remote control track set
- 1 to 7 sections of straight track
- Bottle of Smoke Pellets (with smoke locomotives)
- Tube of Lionel lubricant
- 1 track lockon

In addition, all "O27" outfits include a transformer which is packed with the necessary connecting wires.

Examine the equipment to see that it is in good condition. Spin all the car wheels to see that they turn freely. Put a very small dab of Lionel lubricant on the ends of the axles.

If your locomotive is one of those where the motor can be seen from the side (see sketch on page 52), you should lubricate the ends of the armature shaft before you run the locomotive. Your outfit may have been stored on the dealer's shelves for several months and the lubricant put on in the factory may have been absorbed by the wrapping paper.

Those Lionel locomotives where the motor is concealed have a large lubricant reservoir which is filled at the factory and does not require any attention for a long time.

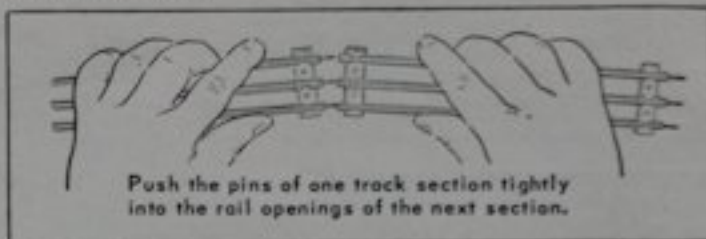

### Join the Track Sections

The track should fit together tightly for good electrical contact. If the rail openings have been distorted or enlarged either through long use or accident they should be reshaped by using Lionel Track Pliers, as described on page 37.

One Remote Control Track Set, used for uncoupling and operating cars, is supplied with each outfit. As many additional sets as you like can be used in a layout. Remote Control Track sections are assembled like any ordinary straight section.

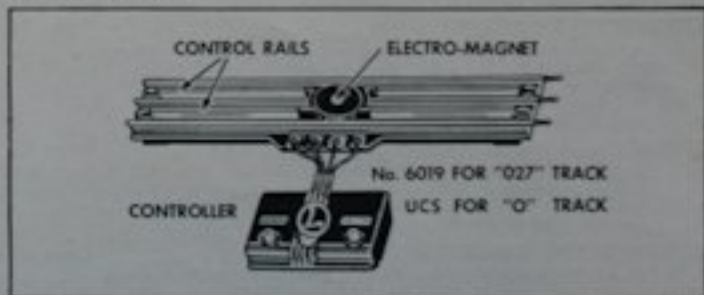

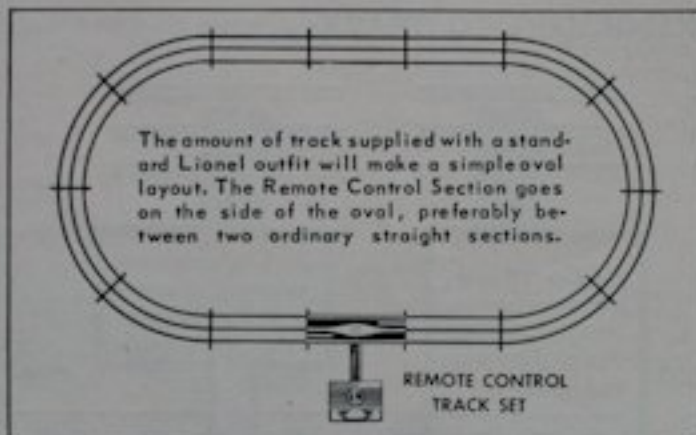

### Attach the Lockon to Track

After track is assembled, attach a lockon to one of the straight track sections. Lockons are used for connecting wires from the track to the transformer. One CTC Lockon is supplied with each outfit. To dress up your outfit you can

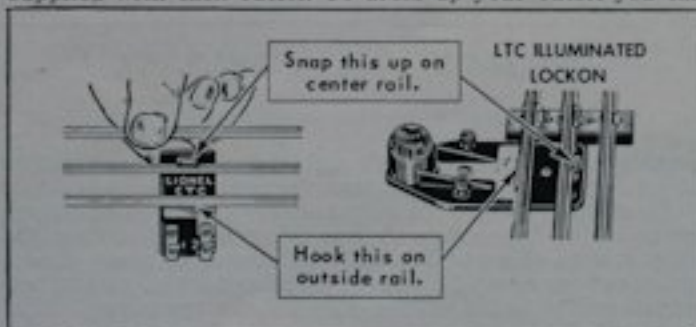

use LTC Illuminated Lockons available at your dealer.

Insulated connecting wires, or leads, are supplied coiled for convenience. You can straighten them out if you like. Before making connections remove the insulating covering.

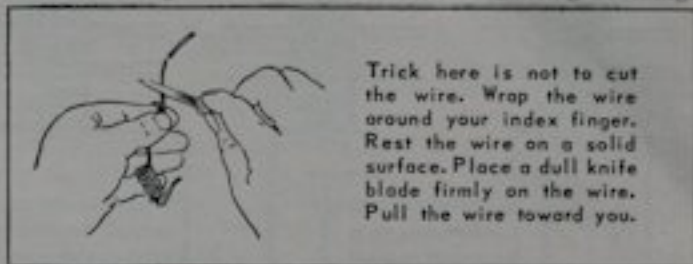

### Connect Lockon to Transformer

The two lockon clips are now connected to a pair of transformer binding posts. See next page for the correct posts.

Push the springy upper half of the clip down until the metal loop in the lower part projects through the slot in the top. Insert the bare wire end through the loop and release the clip. Repeat with the other clip. Connect the other ends of the wires to transformer. Wrap the bare end of the wire around the post clockwise. Then the wire will not slip out as you tighten the thumb nut.

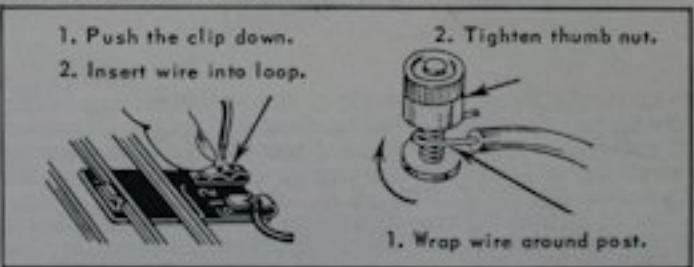

## HOW TO CONNECT TRANSFORMERS TO TRACK

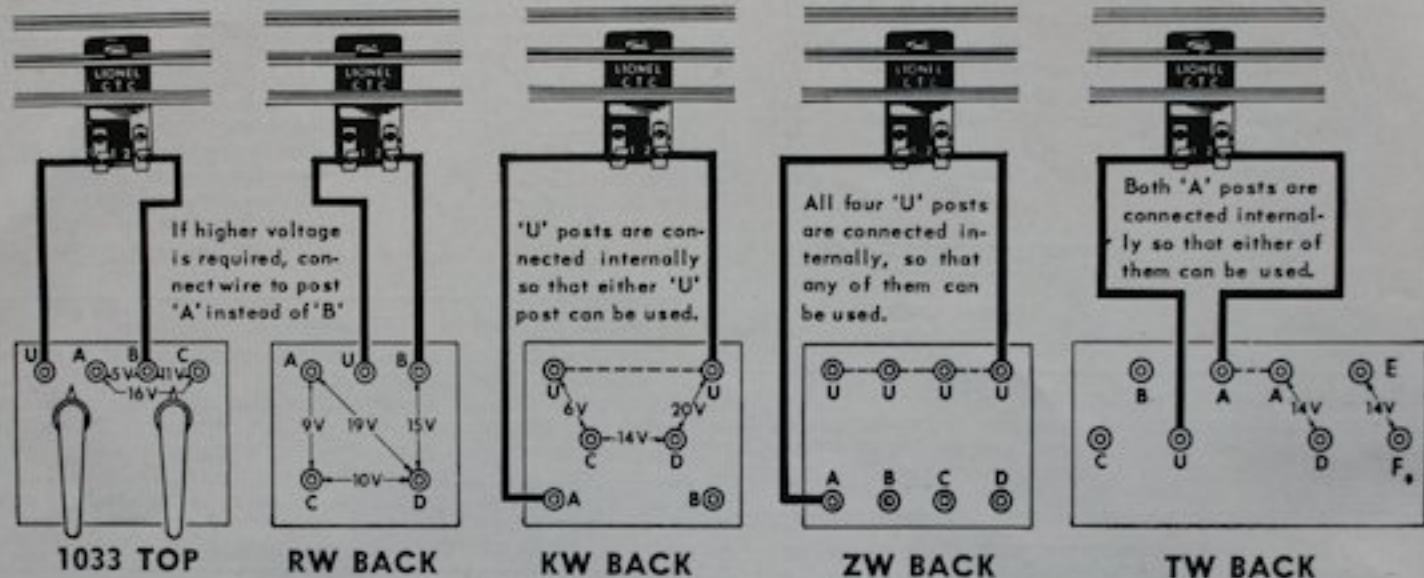

In simple layouts the order of the two wires connecting the transformer to the lockon does not matter. However, if you are going to use insulated track blocks or accessories requiring a fixed voltage connection, such as No. 022 Switches, No. 456 Coal Ramp or No. 3656 Corral Platform, start by wiring the transformer to track exactly as shown. For further information about Lionel transformers see the

section on "Power Supply" and the detailed instruction sheet furnished with each transformer.

In some cases you may find that the wiring directions given in the instruction leaflets differ somewhat from the diagrams in this booklet. This is because in many Lionel transformers several different combinations of output terminals will give the voltage required for operating trains.

## Place Train on the Track

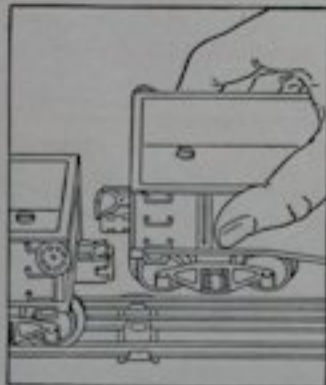

Place the locomotive and tender on the track and join them with the locomotive drawbar. Couple on the other cars by raising the end of the car and engaging the couplers by hand. Train can be assembled most easily on a straight portion of the track. After placing a locomotive or car on the track roll it back and forth to make sure that all the wheels are properly set on the rails. If not, they may touch the center rail and cause a "short circuit" so that the train won't run.

## Short Circuits

Most troubles in running an electric train are due to short circuits caused by a derailed wheel touching the center rail. A "short circuit" is a condition where the electric current by-passes the motor or other device it is supposed to operate and flows to the outside rail which is connected directly to the transformer. When a short circuit occurs the train stops, the lights dim or go out altogether; the transformer overheats and, if unprotected, will burn out.

To protect them from overheating and damage due to short circuits most Lionel transformers are equipped with built-in circuit breakers. A few seconds after a short circuit occurs, the circuit breaker opens and cuts off the output of the transformer. After a short time the circuit breaker closes automatically but will reopen almost immediately if the short circuit still exists. Lionel transformers RW, KW and ZW are also equipped with red warning lights which flash on whenever a circuit breaker operates.

"Wipe Your Track Regularly"

## Check These Trouble Spots

A derailed car truck. If trouble persists remove all cars and locomotive from the track. Then look for:

Nails, screws, pins, etc. across the track. Sometimes a "magnetraction" locomotive will pick up a small iron object and hold it to the track from underneath.

Long wire ends connected to the two lockon clips touching each other.

A bare wire touching two binding posts of a transformer or an accessory piece of equipment.

Broken or displaced insulation between center rail and track tie. This may sometimes be difficult to find. If necessary check each track section separately.

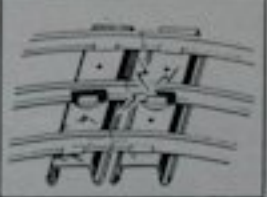
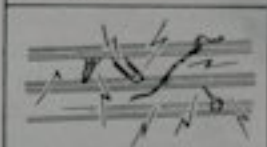
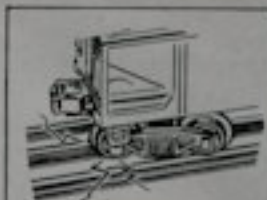



## HOW TO OPERATE THE TRAIN

### Regulating Train Speed

The speed of the train is regulated by moving the voltage control on the transformer panel. The higher the voltage the greater the speed. Most Lionel transformers provide at least two different variable voltage ranges. The lower range is for light trains; the higher range for heavier trains.

### Reversing the Locomotive

Lionel locomotives can be stopped and reversed by *remote control*. The reversing mechanism, known as the E-Unit, is inside the locomotive. It is operated by momentary interruptions of current to the locomotive. This can be done by operating the "Direction" control on the transformer or by turning the voltage control to "Off". (Accidental "shorting" of the track, loose connecting wires, missing track pins or dirty track will also cause E-Unit to operate.)

The E-Unit has three positions which operate in sequence: Forward, Stop, Reverse, Stop, etc. The Stop or Neutral position is necessary to halt the train with its lights on.

*When the locomotive is running, move the "Direction" control ONCE to stop, and TWICE to reverse.*

### How to Disconnect the Reversing Mechanism

The E-Unit can be disconnected by moving the E-Unit lever to its OFF position. With this mechanism disconnected the locomotive will not reverse its direction after being stopped, but will resume running in the same direction. The E-Unit should be disconnected when you have an automatic station, an operating bridge or insulated track blocks.

#### *To disconnect E-Unit:*

1. Start the locomotive going in the desired direction.
2. Stop it with your hand or by turning off track power. (Do not operate the "Direction" control.)
3. Move the E-Unit lever to OFF.

*Note: If the E-Unit is disconnected while it is in Neutral position, the locomotive will not run at all. Also, because it is operated partly by gravity the E-Unit will not work properly if the locomotive is held on its side or upside down.*

### Location of E-Unit Lever

In most steam-type locomotives E-Unit lever is on top of the boiler, back of the smoke stack or behind the sand dome. In 1954 the one exception is Locomotive No. 1130 where the lever is on the bottom, under the cab.



On "O" twin diesels built in 1954 the E-Unit lever is on the bottom of the power car. Forward is OFF position. Back is ON.



On "027" twin diesels the E-Unit lever is on the bottom of the power section, back of the horn battery cover. Toward the cover screw is ON position. Away from it is OFF.





## Sounding the Whistle or Horn

Following actual railroading practice most Lionel steam-type trains are equipped with a two-tone whistle while diesel types contain a warning horn. The whistle mechanism is mounted in the locomotive tender. Both the whistle and the horn can be sounded anywhere on the track by operating the whistle controller built into most modern Lionel transformers. If you have an old-fashioned transformer without a built-in whistle controller, a separate No. 167 Whistle Controller must be used. (See page 40).

*Note:* Lionel remote control horn and whistle can be used only with *alternating current* having a frequency of more than 40 cycles. When line frequency is less than 40 cycles (some parts of Canada and some communities in the United States use 25-cycle power lines) the whistle and horn will sound continuously and should therefore be disconnected.

## Operation of the Horn

The power for operating the whistle is supplied by the track, but the warning horns use a flashlight cell supplied with the locomotive. When it is worn out it can be replaced by any standard size D flashlight cell. You can use any good nationally-advertised dry cell but dry cells of the "leak-proof" type are best.

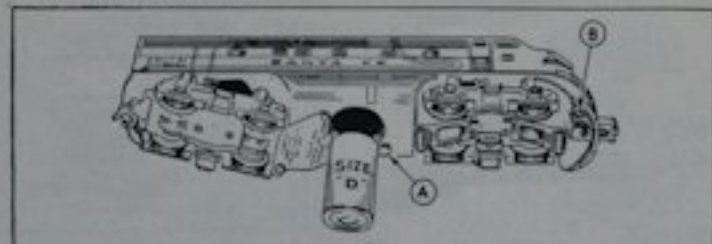

Illustration above shows the location of the dry cell used for the diesel horns. Screw "A" holds the dry cell cover. Screw "B" holds the locomotive body.

"Wipe Your Track Regularly"

The horn will sound whenever the car containing it is tilted or held upside down because in these positions the relay will close through its own weight. For this reason take out the flashlight cell whenever the locomotive is to be transported. To prevent possible damage due to leakage the cell should also be removed when the locomotive is stored away, particularly if the storage place is damp or unheated.

## "Magne-Traction"\* Locomotives

"Magne-Traction" is a Lionel patented development whereby magnetic force is supplied to the locomotive wheels by means of a powerful Alnico magnet, to enable the locomotive to climb steep grades and to pull heavy loads without slipping on the track.

Be careful not to let pins, paper clips, carpet tacks or other loose small iron objects come in contact with the wheels, gears or axles because they may jam up the locomotive mechanism. To obtain the benefit of "Magne-Traction" use only steel rails. Magnetism is not effective on aluminum or brass rails.

*Note:* In 1954 all Lionel locomotives with the exception of No. 1130 are equipped with "Magne-Traction".

\* Registered in the United States Patent Office.

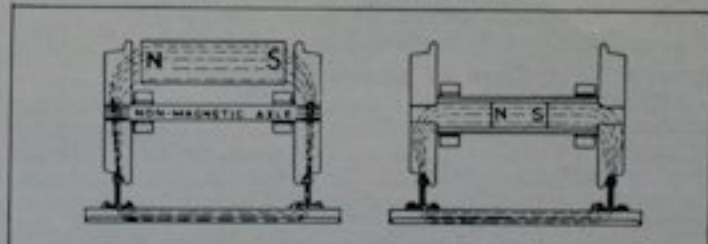

The sketch above illustrates how "Magne-Traction" is achieved in modern Lionel locomotives. On the left the magnet is placed next to the wheels. On the right it is inserted into the axle itself.

## Lionel "Smoke" Locomotives

Most Lionel steam-type locomotives are equipped with a smoke generator which produces odorless, realistic "smoke". Drop a smoke pellet into the locomotive stack and turn on the track power. In a few seconds the heater in the smoke generator melts the pellet and smoke rises from the stack. The locomotive will puff only when the wheels are turning.

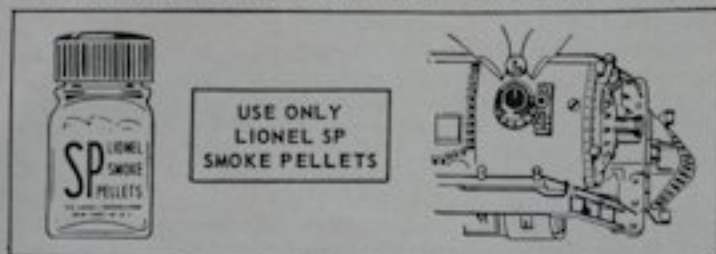

Use only Lionel SP Smoke Pellets. Any other material may damage the heating element in the smoke generator.

For best results use up one pellet before dropping in another. Too many pellets will actually decrease the smoke.

SP Smoke Pellets have been rigorously tested by recognized testing laboratories. They are absolutely harmless even if accidentally swallowed by a small child.

### How to Take Care of Smoke Locomotives

After the locomotive has been used for a while it may produce less smoke than it did at first. This may be caused by smoke material clogging up the stack, or the small air opening inside the generator. Clean out the stack, increase the track power slightly and let the locomotive stand in neutral for a few minutes. This treatment will melt the smoke material. Then lift the locomotive slightly to allow the wheels to turn rapidly. After a few minutes the locomotive will puff as well as ever.

## Coupling and Uncoupling

All standard Lionel cars and tenders are equipped with remote control operating knuckle couplers. Open couplers are closed mechanically, simply by pushing two mating couplers together until their knuckles close and latch. This operation can be done along any straight portion of track provided that at least one of the mating couplers is open. Closed couplers are opened on a Remote Control Track.

Two types of couplers are used by Lionel: "magnetic" and "electro-magnetic". Most 1954 cars as well as No. 2321 Diesel locomotive have "magnetic" couplers. To open a "magnetic" coupler move the car to the Remote Control Section so that the truck you wish opened is over the central electro-magnet. Then push the "Uncouple" button.

Diesel locomotives and some of the longer cars are equipped with "electro-magnetic" couplers. To open these move the car or locomotive to the Remote Control Section so that the sliding shoe connected to the coupler rides up on the control rail. Then push the "Uncouple" button.

*Note:* Previously made RCS and No. 1019 Remote Control Sections have no central electro-magnet and will not open "magnetic" couplers.

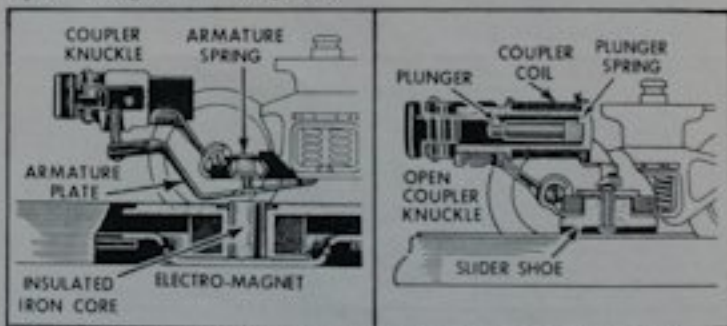

Illustration on the left shows the mechanism of a "magnetic" coupler. The illustration on the right shows an "electro-magnetic" coupler.

## AUTOMATIC OPERATING CARS

Many Lionel train outfits contain automatic cars which are unloaded or otherwise operated by means of the remote control track.

### Cars Using Contact Sliders

The mechanism of most *unloading* cars, such as the Milk Car and the Coal and Lumber Dump Cars, is powered by an electrical coil, or *solenoid*, which gets current from the track through the two sliding contact shoes on the bottom of the car. To operate such cars position them on the remote control section so that both contact shoes rest on the control rails. Then push the "UNLOAD" button.

*Note:* No. 6009 uncoupling section supplied with Lionel train outfits Nos. 1500 and 1513S will not unload cars of this type.

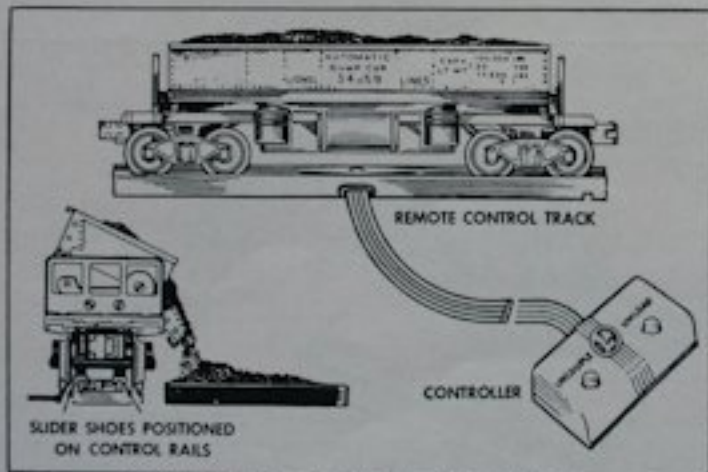

An Automatic Dump Car Positioned for Unloading

"Wipe Your Track Regularly"

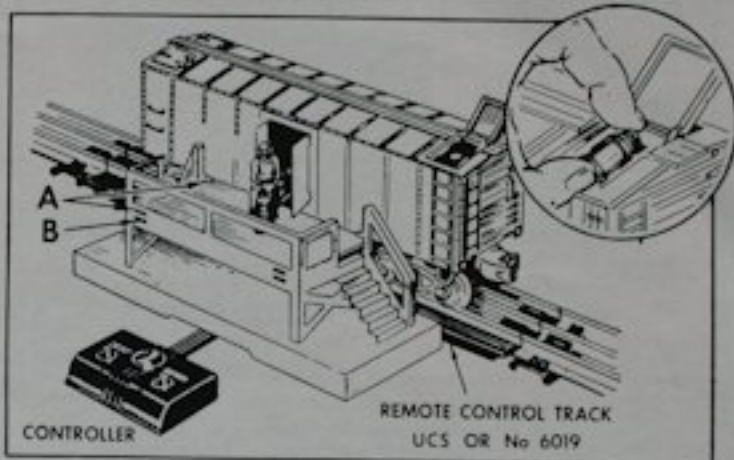

### No. 3482 Automatic Milk Car

Install the unloading platform provided with the Milk Car next to a remote control track section. The height of the platform is adjustable for "O" and "027" track. When used with "O" track the floor of the platform is inserted into the top "A" slots in the frame; when used with "027" track bottom slots "B" should be used. Simply pull out the platform and insert it into the proper slots and the corresponding notches on the track side of the framework.

The miniature milk cans furnished with the car are loaded through the hatch in the roof. Do not try to load any more than 7 cans into the car. Press "Unload" button to unload cans. Adjust track voltage until milkman unloads the cans vigorously but without knocking them over.



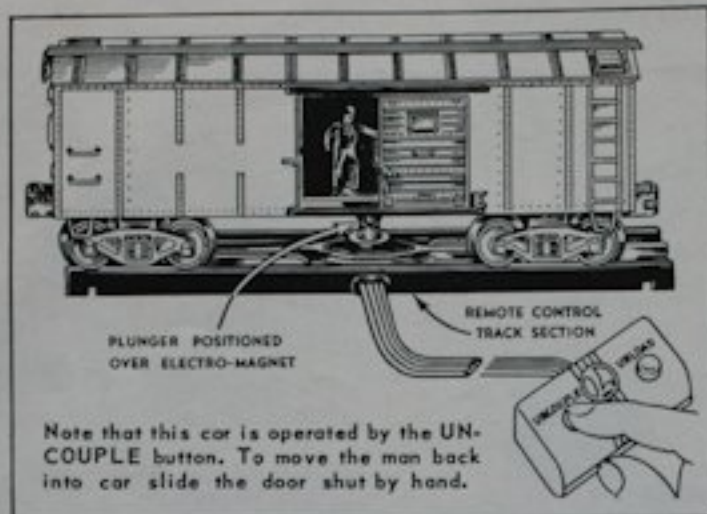

### Plunger-Operated Cars

Operating cars such as the Animated Box Car do not make an electrical contact with the control rails. Instead, their mechanism is operated by an iron plunger, or armature, projecting from the bottom of the car. To operate these cars position them on the remote control section so that the plunger is directly over the electro-magnet; then press the "UNCOUPLE" button of the controller. Cars of this type can be operated by Remote Control Sections UCS, 6019 and 6009.

### No. 3562 Operating Barrel Car

No. 3562 Barrel Car is equipped with a vibrating mechanism which causes the barrels loaded on it to move along the car floor until they reach the chute at the end of the

car and fall off. The car is operated by positioning it so that one of its sliding shoes rests on the OTC contactor supplied with the car and pressing the controller button. The OTC contactor is clamped on the track like a lockon and the height of its control rails is adjustable to match the height of "O" and "027" track.

This car can also be operated on any regular remote control section by setting its right-hand slide shoe on the right-hand end of the remote control section and pressing the "Unload" button. However, if both sliding shoes are on the control rails pressing the "Unload" button will cause a short.

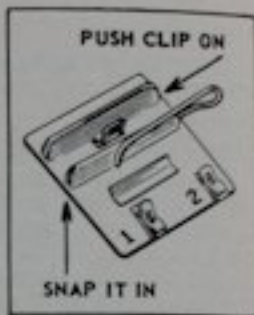

Adjusting Height of OTC Contactor Control Rails for "O" Track.

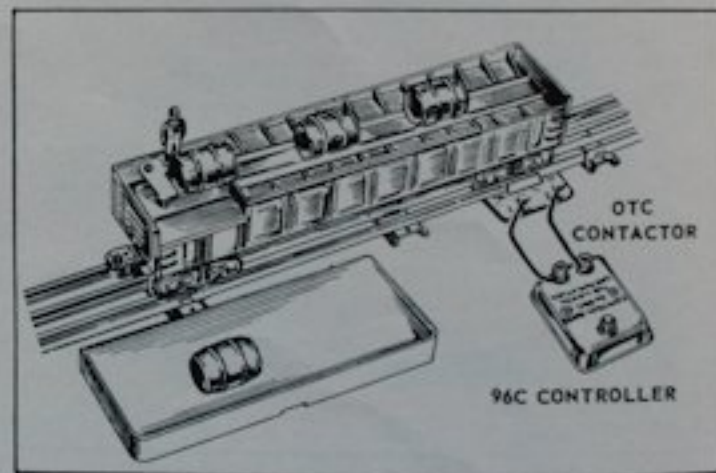

"Clean and Lubricate Your Equipment"

## No. 3656 Operating Stock Car

This car does not use the regular remote control track but is operated by means of contacts built into its corral platform base. The platform is assembled to a straight portion of the track (either "O" or "027" track may be used) and is wired to a No. 364C controller. The power can be obtained either from the track, by means of a lockon, or directly from a fixed voltage post on the transformer.

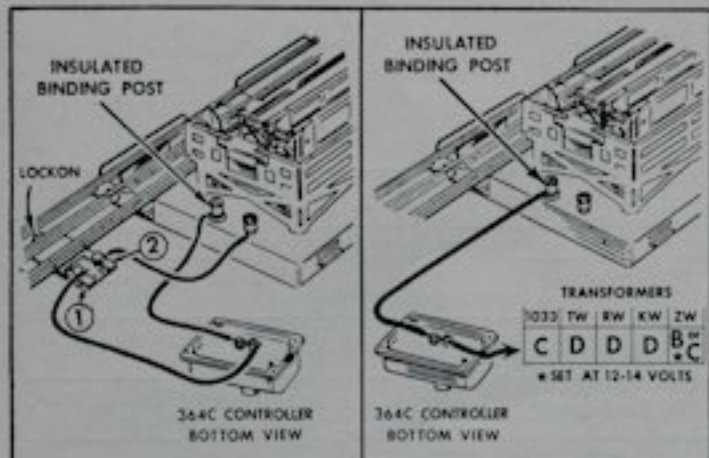

The wiring diagrams above show two alternate methods for hooking up the corral platform. In order to use fixed voltage method on the right the transformer must be connected to the track as shown on page 4.

After the platform is properly assembled, line up the miniature cattle in any desired corral passage, position the car accurately in front of the platform and press the controller button. The car doors will rise and the vibrating platform floor will cause the cattle to move into the car.

"Wipe Your Track Regularly"

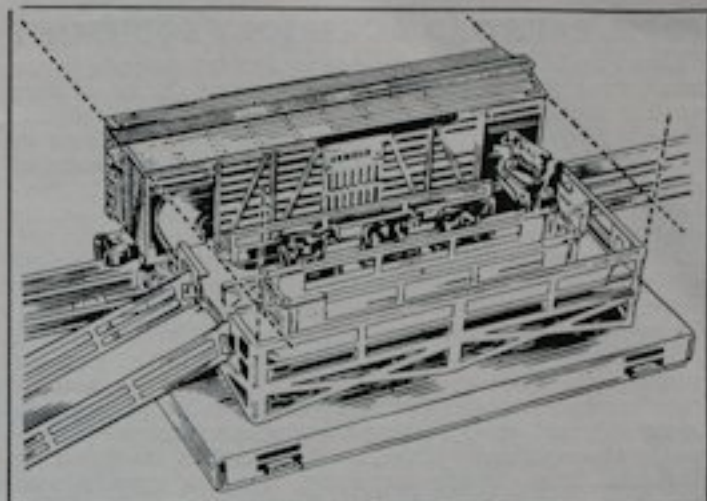

Operating Stock Car Positioned at the Corral Platform. Note that the Car Must Be Accurately Aligned with the Platform Ends.

If sliding door on the opposite side of the car is closed the cattle will remain in the car. If open cattle will pass through.

Note that the base of the miniature cattle is equipped with tiny projections, or "fingers". These projections are so designed as to move the cattle in the correct direction and to turn them around corners of the corral platform and the car runway. Don't destroy or alter them in any way or you will destroy their action. A little Lionel lubricant on the edge of the base will help the cattle move around corners.



## MODEL RAILROAD ACCESSORY EQUIPMENT

Lionel model railroad accessory equipment depends on the transformer for its operating power and works on voltages ranging from 10 to 14 volts. The higher portion of this range is frequently required when the working parts on an accessory are new, but the voltage can usually be decreased as the mechanism becomes worn in. If an accessory is operated continuously for a long period of time, however, its operating voltage rises as its coil or motor warm up in use.

As explained in the section on "Power Supply" the actual voltages supplied by the transformer posts under operating conditions may differ considerably from the "nominal" voltages marked on the transformer panel. For this reason it is not always possible to give a hard and fast rule for connecting a piece of equipment to a particular pair of transformer terminals. The best practice is to connect it to a pair of transformer binding posts which furnish approximately the required voltage, as indicated in most wiring diagrams. Then, if the accessory does not operate with enough snap, shift to the next higher available voltage. For some accessories of the vibrating type it is best to use variable voltage which can be adjusted precisely to give the best operation.

It is good practice to run any Lionel operating or illuminated accessory at the lowest possible voltage.

In this way you will prevent unnecessary wear of equipment and prolong the life of the lamps. A summary table listing the actual operating voltages required by various Lionel accessories is found on the right.

The number of operating accessories which can be used with your model railroad is limited only by the wattage rating of your transformer as discussed in the section on Power Supply. In most cases, however, since these accessories consume power only when in actual operation, many more of them can be operated on a transformer than the total of their wattages would indicate.

Illuminated Non-Operating Accessories		
71 Lamp Post 157 Station Platform 193 Water Tower 394 and 494 Beacons 395 Floodlight	12-14 volts	Use fixed voltage slightly lower than specified, to prolong lamp life. Also see page 13.
Automatic Signals		
140 Banjo Signal 145 Gateman 151 Semaphore 153 Stop Signal 252 Crossing Gate 445 Switch Tower 450 Signal Bridge	10-14 volts	These accessories receive fixed voltage through No. 145C or No. 153C Contactors. See pages 14 to 18.
154 Highway Signal	9-14 volts	This receives track voltage through 154C contactor.
Track and Operating Accessories		
260 Bumper 1122 Switches	9-14 volts	Track voltage. No wiring required.
*022 Switches *6019 or UCS Track	10-14 volts	Track voltage (no wiring) or fixed voltage.
*456 Coal Ramp	9-14 volts	Track voltage (Through lock-on) or fixed voltage.
*For usable voltage circuits see page 40.		
282 Crane 356 Freight Station 362 Barrel Loader 364 Lumber Loader 397 Coal Loader 455 Oil Derrick	10-14 volts	These accessories operate on fixed voltage. They can be connected to any pair of transformer posts having a nominal voltage from 12 to 16 volts.
125 Whistle Station 132 Stop Station 497 Coaling Station	9-14 volts	Track voltage through Lock-on.



## PARALLEL CONNECTIONS

In the event you have several railroad accessories requiring the same voltage it is advisable to use the same pair of transformer binding posts for all of them, wiring them together in "parallel", as shown below. Two main feeders go to the transformer posts and individual wires go from these feeders to the accessories. In this way unnecessary wiring is eliminated. If your outfit is mounted on a table or platform the main feeders can be stapled to the under side of the table and small holes drilled next to each accessory for the wires leading to the accessory.

The feeders can be made from ordinary lamp cord or thin metal strips. In permanent layouts the wire connections are frequently soldered together.

Most operating accessories can also be wired in this manner with the various switches and controllers inserted in one of the connecting wires, as shown.

Remember that if two or more 14-volt accessories are wired together in "parallel", they must still be connected to the 14-volt posts on the transformer and not to posts which give the total of the individual voltages required.

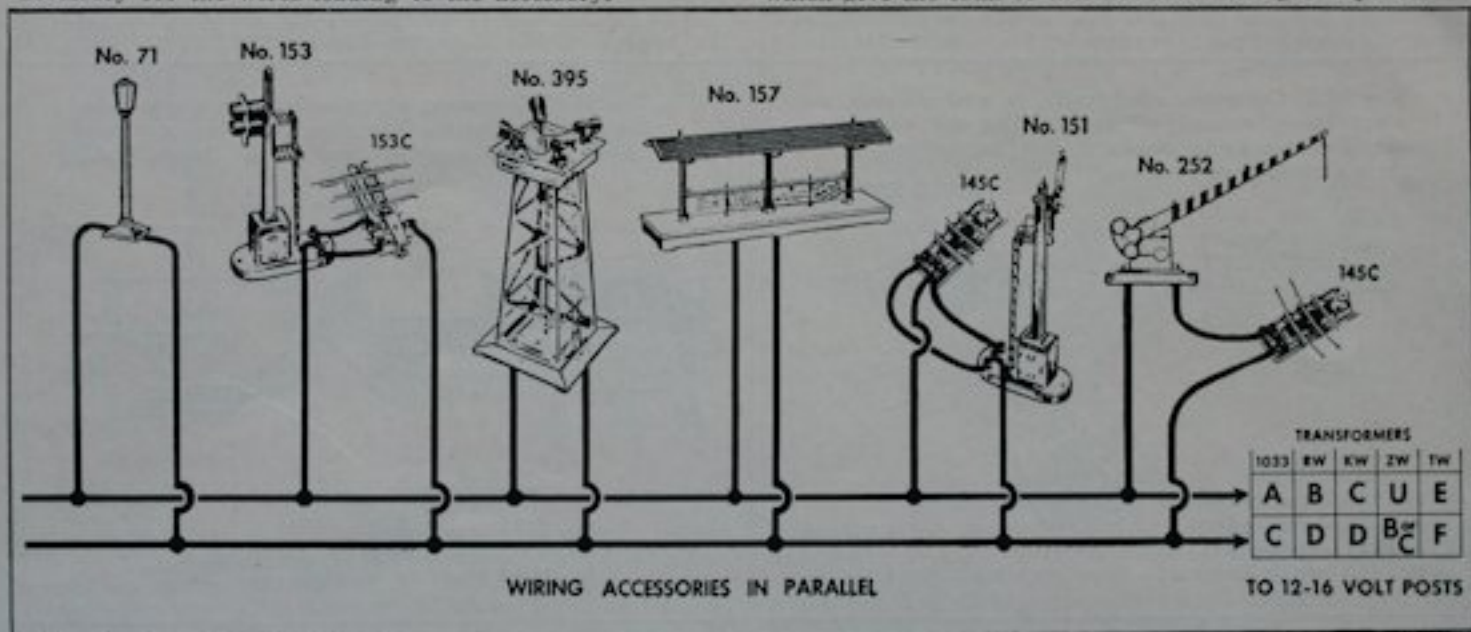

## AUTOMATIC SIGNALING

Model railroad signals and trackside accessories made by Lionel are usually operated automatically by means of "contactors" actuated by a passing train. Contactors 145C and 153C are worked mechanically by the weight of the train. Others are operated electrically by the train wheels making an electrical contact with the contactor surface and in this way completing the electrical circuit.

*Pressure-type contactors are placed underneath the track so that a track tie rests firmly on top of the contactor. If the track is fastened to a platform make sure the track is loose for several sections on either side of the contactor because the track must be free to bend under the weight of the train.*

An adjustment nut is provided to regulate the weight required to operate the contactor. This is done after all wire connections are made and transformer power is on. Stop the train several sections away from the contactor. Turn the adjustment nut either up or down until the signal operates. Then turn the nut back just enough to return the signal to its normal non-operating position. By varying the setting of the adjustment nut the signal can be made to respond either to the weight of the heavy locomotive alone, or to the lightest car.

*Note:* Automatic operation can also be achieved through the use of special insulated track described on page 37.

The 145C Contactor, electrically, is a single-pole, single-throw, normally-off switch. The end view of the contactor below shows it with its contacts in their normal, open position.

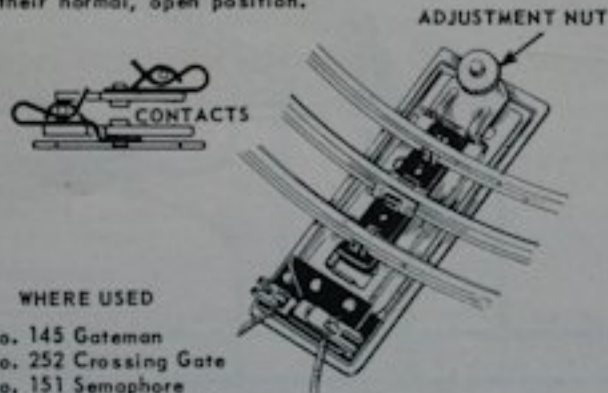

### WHERE USED

- No. 145 Gateman
- No. 252 Crossing Gate
- No. 151 Semaphore
- No. 445 Switch Tower

The 153C Contactor, electrically, is a single-pole, double-throw switch. The diagram of the contactor below shows the normal position of its contacts.

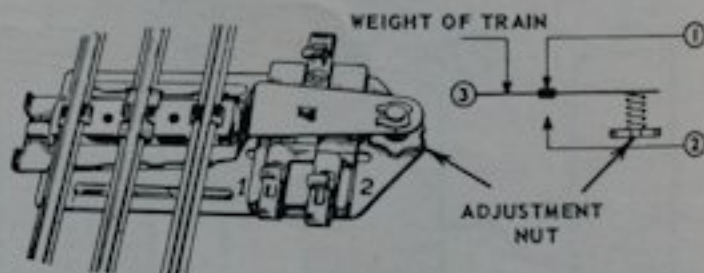

### WHERE USED

- No. 153 Block Signal
- No. 450 Signal Bridge
- Insulated block for two-train operation

## No. 140 BANJO SIGNAL

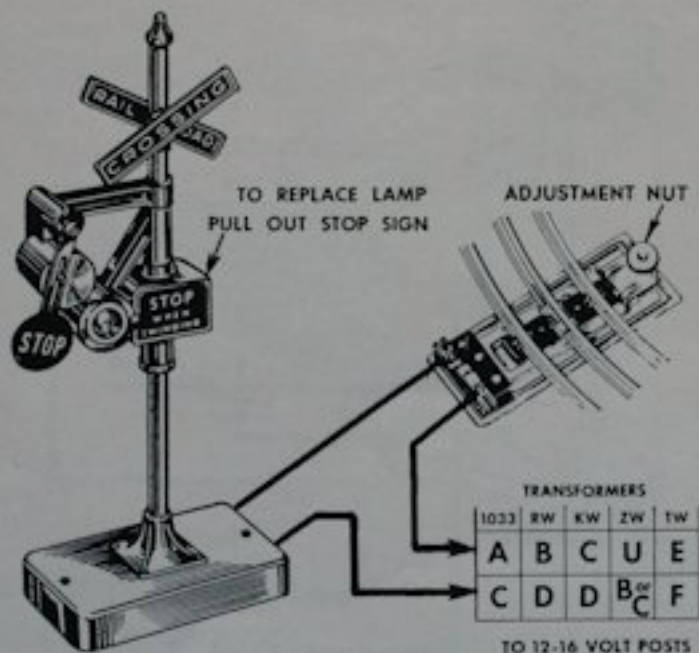

**OPERATION:** As the train passes over the contactor the signal light goes on and the warning arm begins to swing. The action will continue as long as the train is pressing on the contactor. An insulated rail may be used instead of the contactor as illustrated on page 38. To get longer action you can use two contactors or two insulated rails.

**"Wipe Your Track Regularly"**

## No. 145 GATEMAN

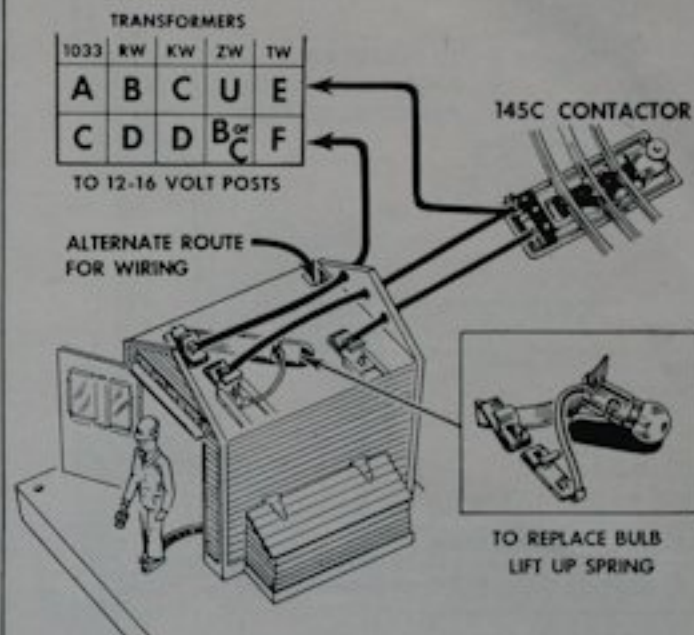

**OPERATION:** Normally light in the shack is on. As train passes over the contactor the door opens and the gateman emerges from the shack. Alternate method of operation by using insulated track is the same as for No. 151 Semaphore. If desired, both accessories can be connected to the same contactor and will operate simultaneously.



### No. 151 SEMAPHORE



TO REPLACE BULB  
REMOVE SCREW AND  
PULL DOWN HOUSING

145C CONTACTOR

TRANSFORMERS

1033	RW	KW	ZW	TW
A	B	C	U	E
C	D	D	B <sub>or</sub> C	F

12-16 VOLTS

**OPERATION:** Normally light shows green and the semaphore arm is up. As the contactor is actuated by a passing train current flows through solenoid. Semaphore arm goes down and light shows red. Alternate hook-ups using insulated track or No. 022 non-derailing switches are described on pages 27 and 38. For use with insulated block see page 30.

### No. 153 BLOCK SIGNAL

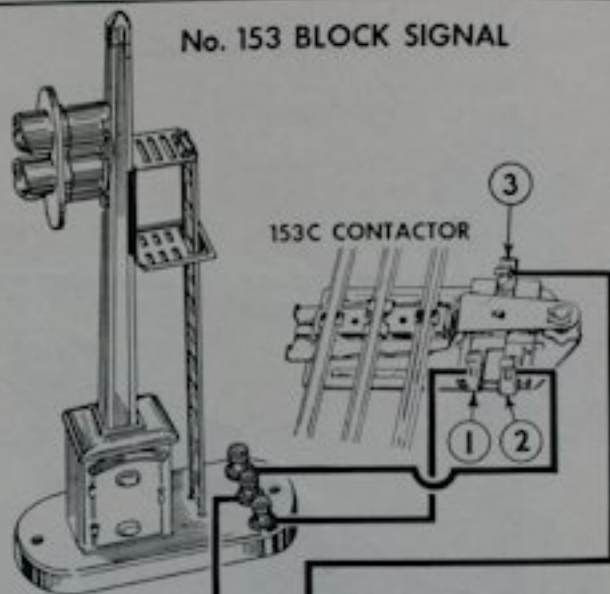

153C CONTACTOR

TO REPLACE BULBS  
PUSH IN SLIGHTLY  
AND TURN TO LEFT

TRANSFORMERS

1033	RW	KW	ZW	TW
A	B	C	U	E
C	D	D	B <sub>or</sub> C	F

TO 12-16 VOLT POSTS

**OPERATION:** Normally current runs from contactor clip 3 to clip 1 illuminating the green light. When contactor is depressed current runs from clip 3 to clip 2, illuminating red light. For alternate hook-up to No. 022 Switches see page 27. For connection to insulated blocks used in two-train operation see page 30.

### No. 445 SWITCH TOWER

TO REMOVE LAMP  
SQUEEZE BRACKET  
AND PULL OUT

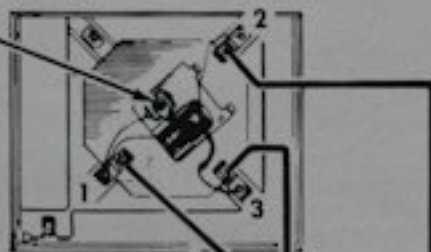

BOTTOM VIEW

TRANSFORMERS

1033	RW	KW	ZW	TW
A	B	C	U	E
C	D	D	B <sup>or</sup> <sub>C</sub>	F

TO 12-16 VOLT POSTS

145C CONTACTOR

**OPERATION:** Switch tower is always illuminated. As the contactor is actuated one of the tower men goes into the tower; the other descends the stairs with his lantern. After the train has passed both towermen return to their original positions. Alternate hook-ups using insulated rails or 022 switches are same as for No. 151 Semaphore and are described on pages 27 and 38.

"Wipe Your Track Regularly"

### WIRING FOR No. 252 CROSSING GATE



TO REPLACE BULB  
PULL OUT BRACKET

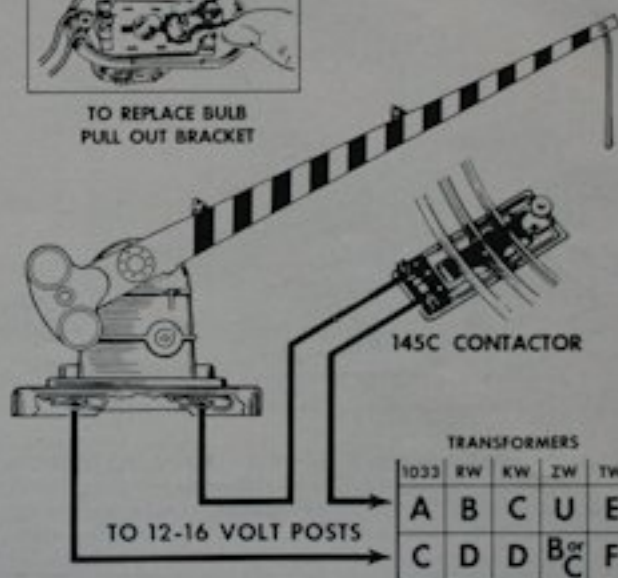

145C CONTACTOR

TRANSFORMERS

1033	RW	KW	ZW	TW
A	B	C	U	E
C	D	D	B <sup>or</sup> <sub>C</sub>	F

TO 12-16 VOLT POSTS

**OPERATION:** Normally the gate is up and the light is out. As train passes over contactor, current flows into solenoid pulling down gate and illuminating the lamp in gate base. An alternate method for operating Crossing Gate by special insulated track instead of the 145C contactor is described on page 38.

## No. 450 SIGNAL BRIDGE

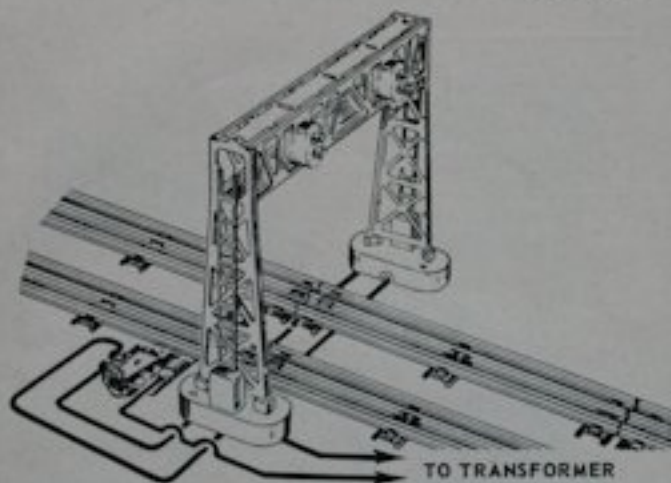

Although the sketch above shows the signal lights facing the same way, one of them can be reversed to face in opposite direction. If the bridge spans single track only mount the lights over each other in the center of the span.

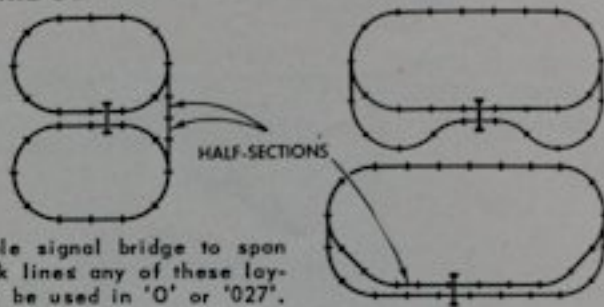

To enable signal bridge to span two track lines any of these layouts can be used in 'O' or '027'.

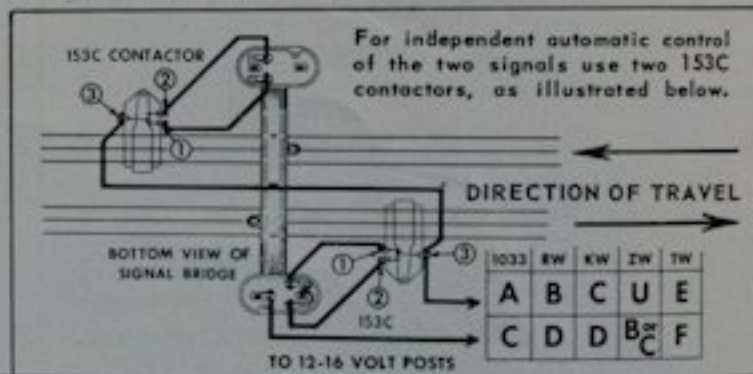

For independent automatic control of the two signals use two 153C contactors, as illustrated below.

**INSTALLATION:** The Signal Bridge will span one or two lines of track. Some typical layouts for two-track installation are shown above. The Signal Bridge is equipped with two red-green signals which can be faced either way or relocated in any of six positions on the bridge structure by removing the screw on the bottom of the signal assembly.

**OPERATION:** Two sets of contact clips are provided in bridge tower bases. To operate both signal lights simultaneously both sets of contacts are connected to one No. 153C contactor. For independent automatic control of the signals two contactors should be used. For manual control substitute a double-throw switch for the contactor.

"Clean and Lubricate Your Equipment"



## No. 154 CROSSING SIGNAL

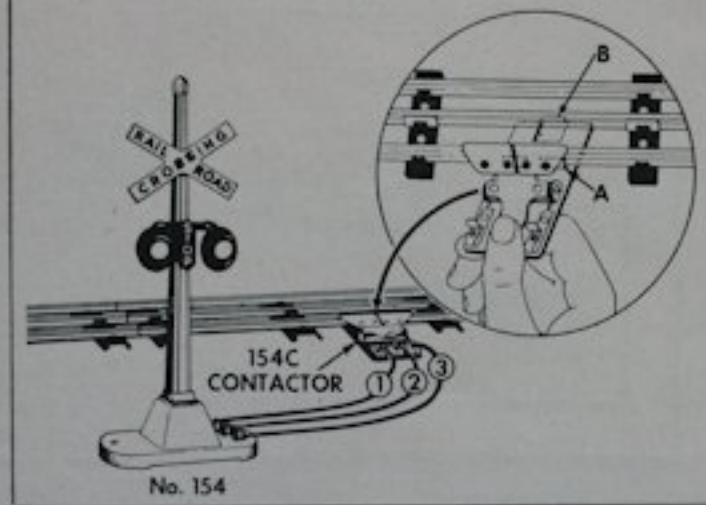

**INSTALLATION:** No. 154 Crossing Signal is connected directly to the track by means of the No. 154C contactor. Attach the contactor to the track by pressing down the spring lever to raise the contact plate, as shown in the inset above; then place contactor under the track with clip "A" gripping the flange of the outside rail, snap spring clip "B" over the center rail, and release the spring lever.

**OPERATION:** As the wheels of the train roll over the contactor surface, the red warning lights of the Crossing Signal will blink alternately. Keep the contacting surfaces of the contactor clean and be careful not to disturb the insulating paper on the inside surface of the plates which touch the rail.

"Wipe Your Track Regularly"

## No. 125 WHISTLING STATION

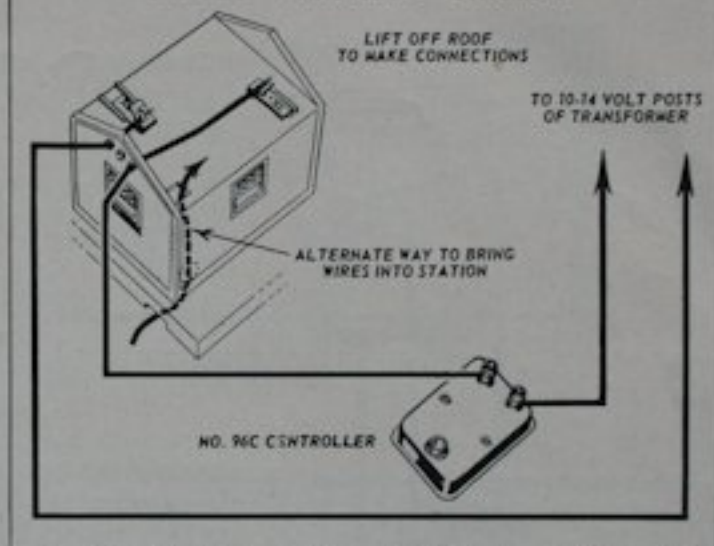

No. 125 Whistling Station is used to advantage with outfits which do not have a built-in whistle or in areas where 25-cycle current is used, making the regular built-in whistle inoperable.

The whistle is sounded by pressing the controller button. For automatic control replace the controller with a 145C contactor installing it under the track in any convenient location as shown on page 14. The whistle will then sound whenever a train passes over that spot in the track.

Note that the connecting wires can be led into the shack either through the holes in the rear wall or through the openings in the floor and the ceiling of the shack.

### NO. 356 FREIGHT STATION

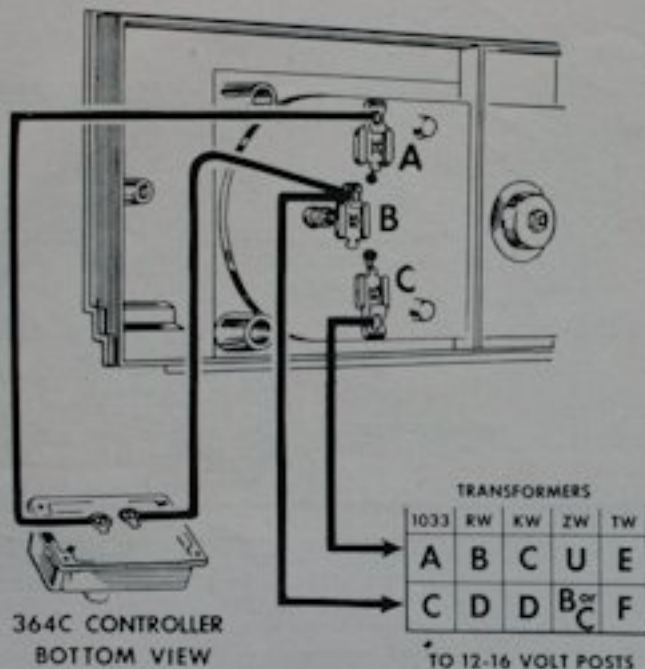

**OPERATION:** When No. 356 Freight Station is connected as above, the light illuminating the station is always on. Pushing the controller switch sets the vibrating station runway into motion, causing the trucks to move in and out of the station house. Motion must be counter-clockwise.

### No. 455 OIL DERRICK

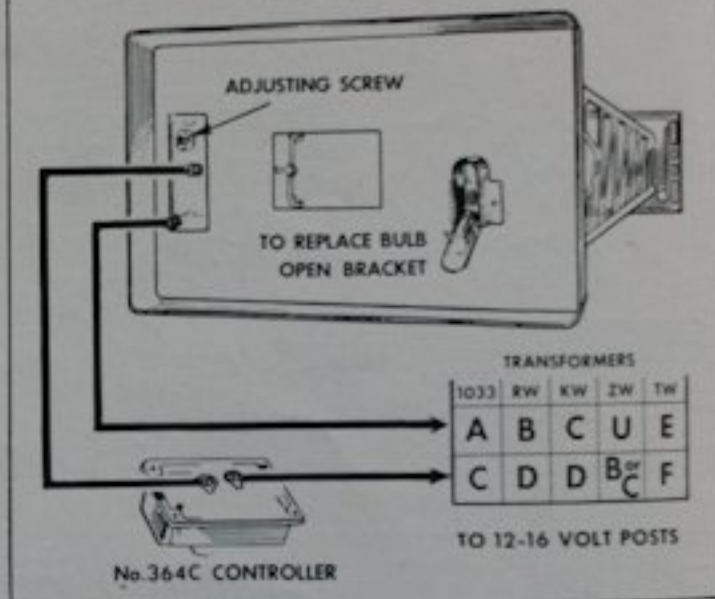

When the 455 Oil Derrick is connected as shown and the controller switched on, the "walking beam" oil pump will start to operate with a slow rocking motion. At the same time the heat of the lamp at the base of the oil column will cause the liquid to bubble, simulating flow of oil.

The speed of the "walking beam" can be regulated by the adjusting screw in the base of the derrick. If you find it necessary to regulate the speed, move the adjusting screw a little at a time and allow a few minutes for the action to "settle down" before re-adjusting the screw.

## NO. 132 AUTOMATIC PASSENGER STATION

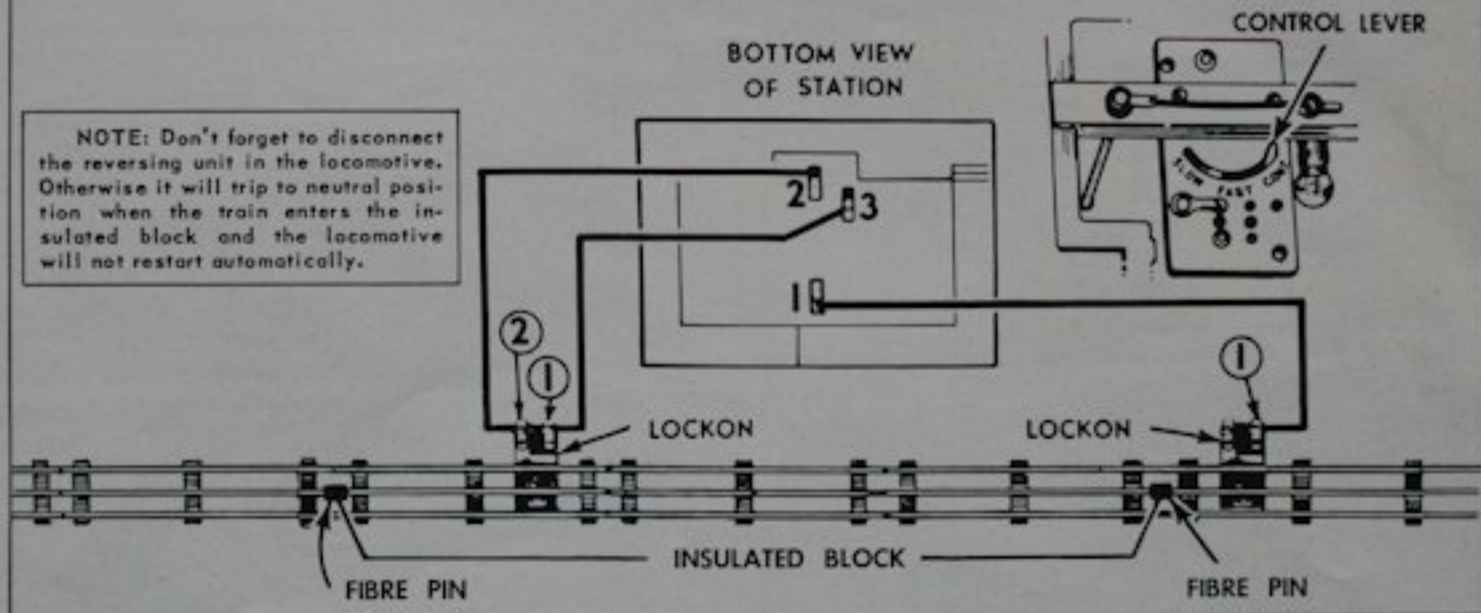

Lionel No. 132 Station is equipped with automatic train control which stops and restarts the train in front of the station. The station is placed anywhere along a straight stretch of track. An insulated block consisting of three or four sections of track is placed directly in front of the station. The insulated block is constructed by pulling out the steel track pins from the center rail at both ends of the block and replacing them with fibre pins. Note that two lockons are used in this installation, one placed within the

insulated block, the other outside of the insulated block.

The length of time a train remains standing in front of the station is regulated by a control lever located underneath the roof of the station as shown in the inset. The simplest way to adjust the station is to start with the control lever at "Continuous" position and gradually move it toward "Slow". Allow the train to make several circuits in each position of the lever before moving it to a new spot. For installation to preserve locomotive reverse see page 31.



### No. 364 LUMBER LOADER

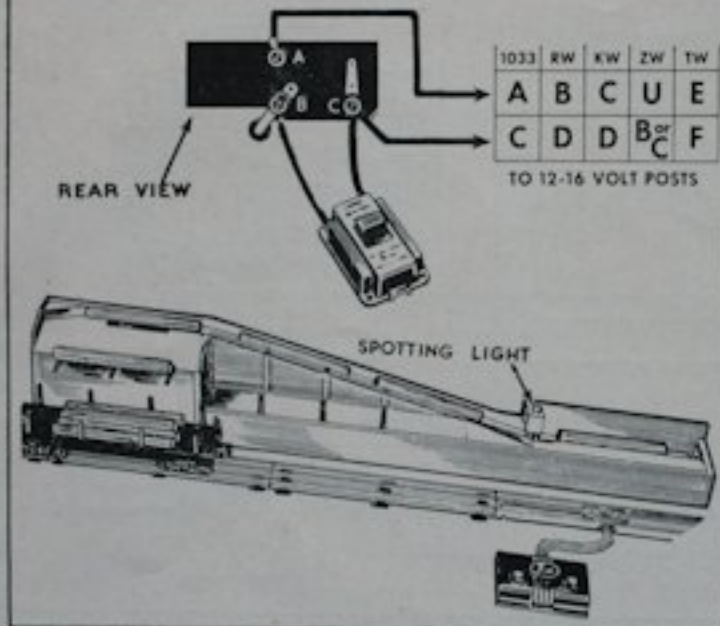

No. 364 Lumber Loader and No. 397 Coal Loader do not require any special track layout but can be located along any straight stretch of track. A remote control section is placed in front of the accessories in such a way that operating lumber or coal cars can be unloaded into the receiving bins. Motorized conveyor belts then carry the material from these bins and reload it into the waiting empties. Note that in the case of the Coal Loader the coal car is loaded and

### No. 397 COAL LOADER

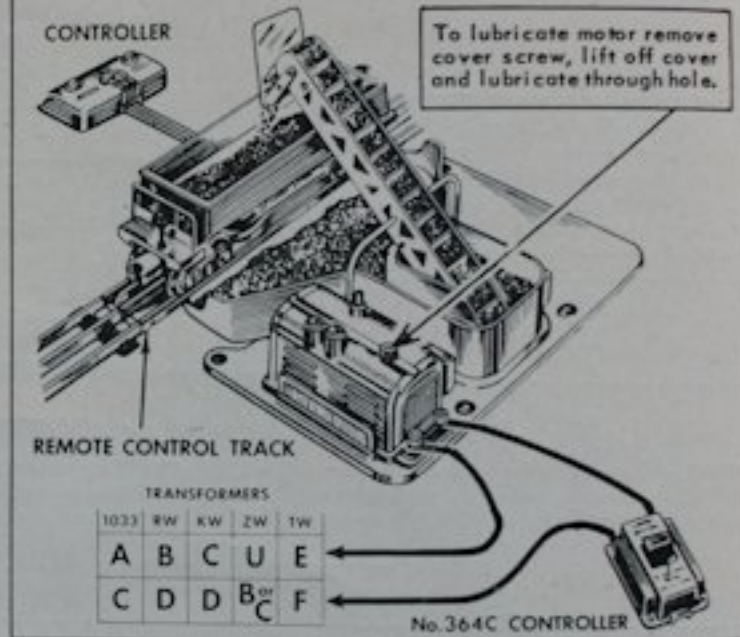

unloaded from the same position on the Remote Control Section, while in the case of the Lumber Loader the empty car must be moved over to the loading station in order to be reloaded.

An interesting installation of the Coal Loader in conjunction with No. 456 Coal Ramp is described on page 24.

The motors in these accessories are similar to those used in Lionel diesel locomotives and require the same care.

### No. 362 BARREL LOADER

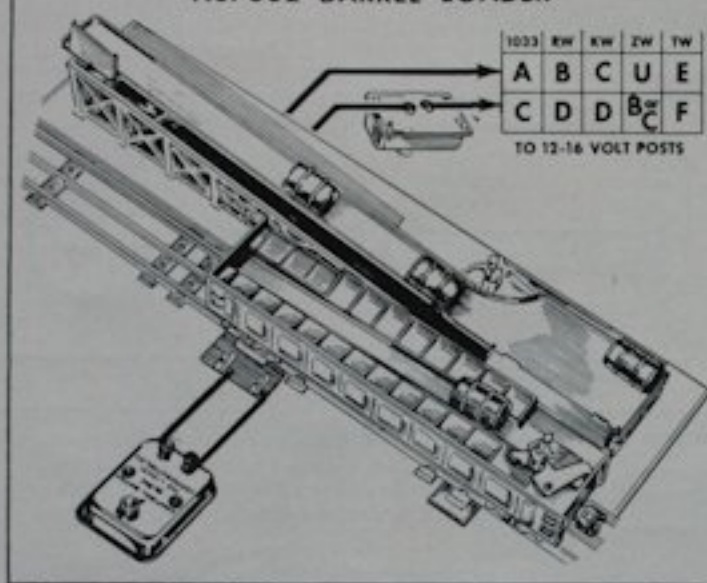

The Barrel Loader can be installed along any straight portion of track at least three sections long. If used with the barrel car, as illustrated, the track must be located so as to permit an OTC contactor to be placed near the center of the loader so that the car can be operated at either end of the loader. The height of the control rails of OTC contactor is adjustable for either "O" or "027" track.

*Note:* Because of individual differences in the adjustment of the loaders, it is frequently advisable to connect them to a source of variable voltage which can then be adjusted precisely to obtain the best operation.

**"Wipe Your Track Regularly"**

### No. 282 GANTRY CRANE

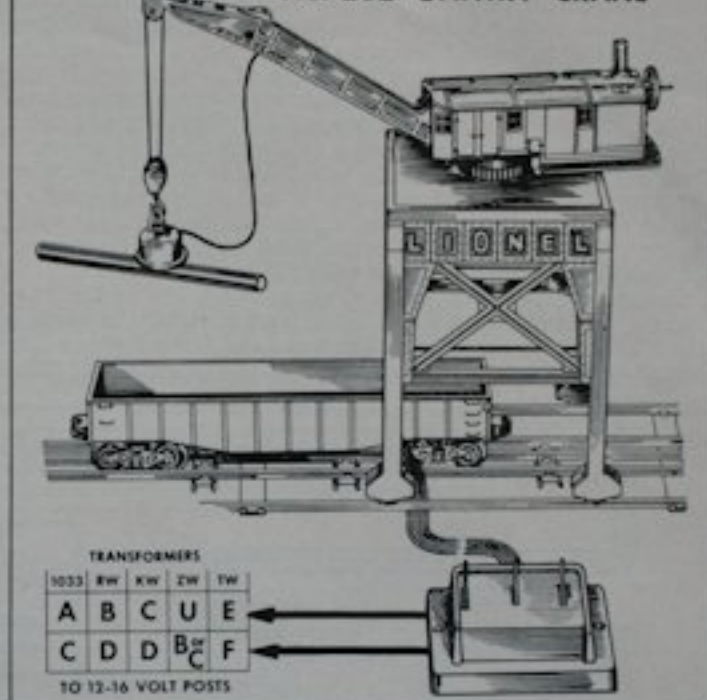

By pushing the proper controller levers, as marked, the cab of No. 282 Gantry Crane can be rotated either clockwise or counter-clockwise; the hook can be raised and lowered; the electromagnet can be energized or de-energized to pick up or release its load of iron. The boom is raised and lowered manually by turning the crank wheel in the back of the cab.

## NO. 456 COAL RAMP SET

No. 456 Coal Ramp Set consists of the elevated ramp and a special operating Hopper Car. It can be used with either "O" or "027" layouts. The ramp is installed on the end of a siding, and is fastened to it by means of two screws.

The ramp is operated by means of a three-button controller which is wired to the ramp and to the transformer. The three-wire cable is connected to the trestle. The separate fourth wire coming out of the controller supplies power for the ramp and should be connected to a fixed voltage post of the transformer. Fixed voltage connection for the ramp will enable you to raise and lower the track voltage to maneuver the train, without interfering with the ramp voltage.

To operate the Hopper Car couple it to the end of the train. (The train must be at least the length of the ramp.) Then back the train up onto the ramp until the Hopper Car latches to the bumper on top of the ramp. Pressing "Un-

couple" button will separate the Hopper Car and allow the rest of the train to depart. To dump the coal from the car push "Unload" button. To release the hopper car from the bumper push the "Release" button.

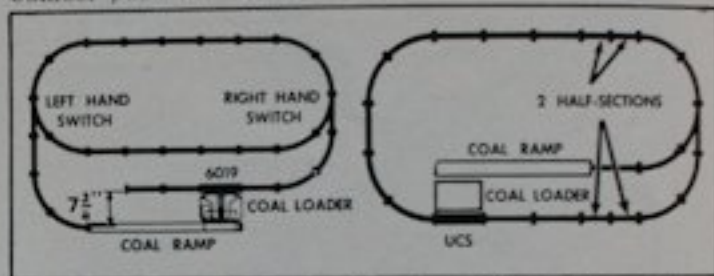

Typical Layouts for Combined Operation of 456 Coal Ramp and 397 Coal Loader: "027" on the Left, "O" on the Right.

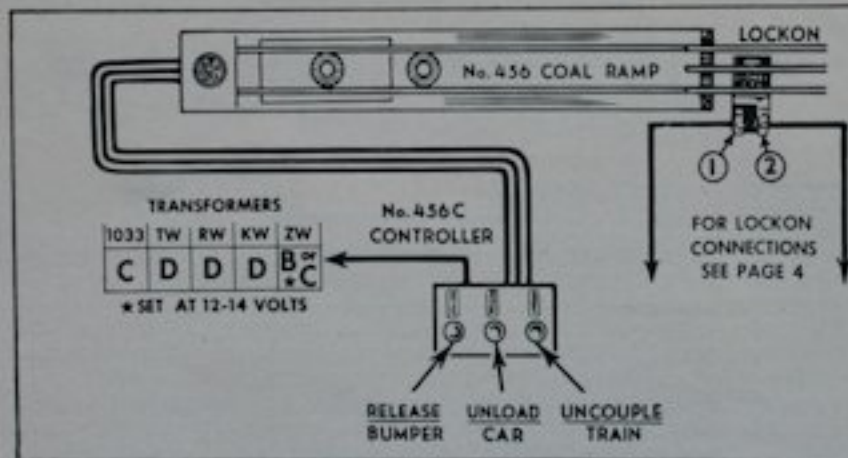

If desired, Cool Ramp can be installed next to No. 397 Coal Loader so that coal from the Hopper Car is dumped directly into the loader bin and then reloaded into a waiting empty.

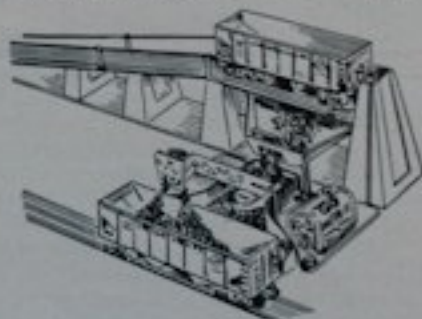

"Clean and Lubricate Your Equipment"



## No. 497 COALING STATION

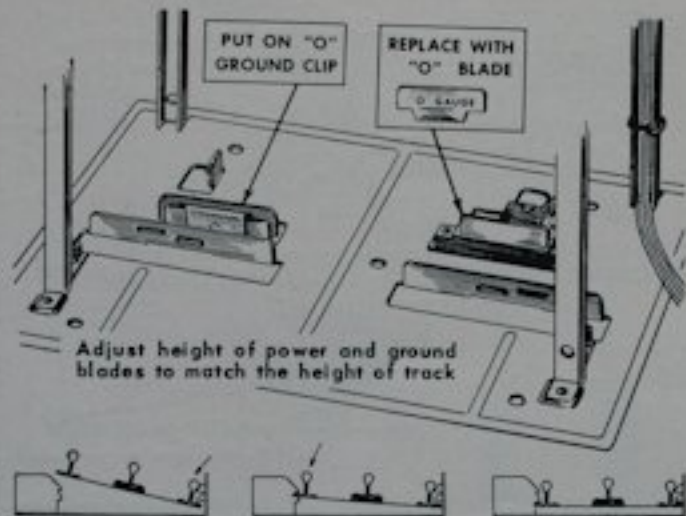

Clip the track to station base.

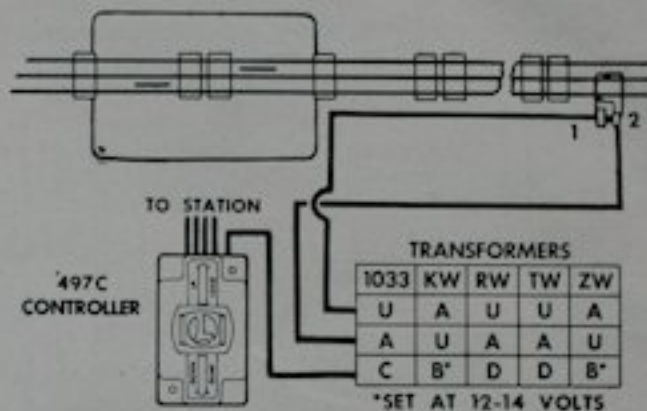

To operate the station on fixed voltage make these connections. To operate on track voltage connect single wire from controller to No. 1 terminal of a lockon

No. 497 Coaling Station can be installed along any straight stretch of track. After making sure that the station base is set up for use with your track size, locate the station so that the joint between two track sections is in the center of the base. A set of notches is provided in the base to lock the track firmly in place. The only electrical connection required is to connect the *single* wire from the controller either to a fixed voltage post of your transformer or, to operate

"Wipe Your Track Regularly"

on track voltage, to No. 1 clip of the track lockon.

To operate, move a loaded coal dump car into the station so that the car's sliding contact shoes rest on the power and ground blades. When the car is in position tilt the coal into the receiving bin by moving controller lever to "DUMP." To carry the coal to the top of the station move the lever to "UP." To bring the tray back move the lever to "DOWN." To load an empty car, move lever to "LOAD."

## INSTALLATION OF No. 022 SWITCHES

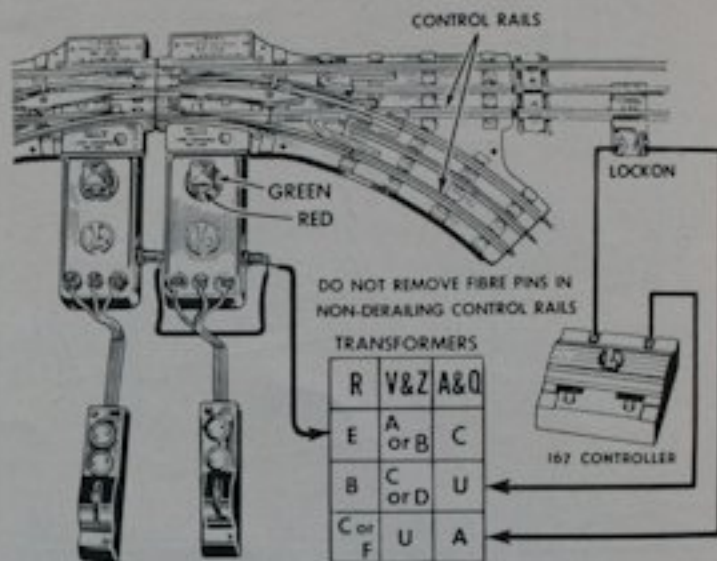
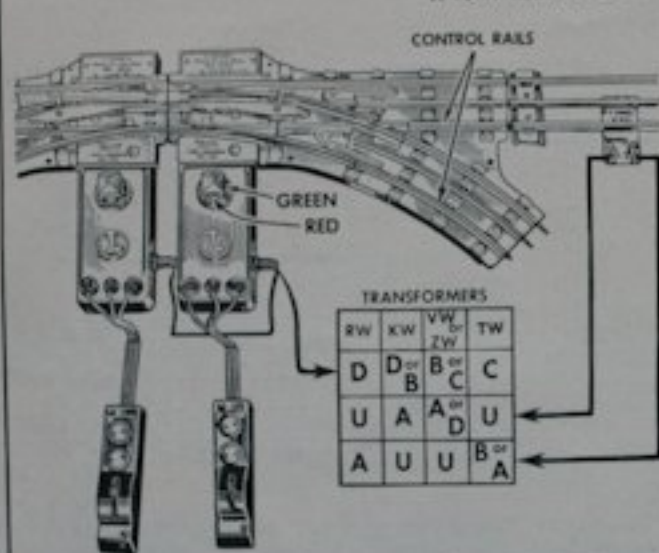

BE SURE PLUG FITS  
OVER CONTACT PIN  
INSIDE SWITCH BOX

WHEN NOT USING FIXED VOLTAGE  
REMOVE PLUG FROM SOCKET

Use of Fixed Voltage Plugs is optional. When they are not used the switch gets power directly from the track.

Keep the non-derailing control rails clean. Do not disturb the fibre pins in the ends of these rails.

When switches are set for train to go along main line the green lights should shine along the straight-away.

## Other Uses of Non-Derailing Mechanism

The automatic non-derailing mechanism of No. 022 switches can be used for several interesting applications. One of them is shown below. If the outside posts of the switches are connected by wires the train will alternate automatically between tracks "A" and "B".

The operation is this: Train leaving track "A" operates the non-derailing mechanism in the "Exit" switch and at the same time throws the "Entry" switch to position which allows the train to enter track "B". Leaving track "B" the train again throws both switches, but this time in the opposite direction, so that it returns to track "A".

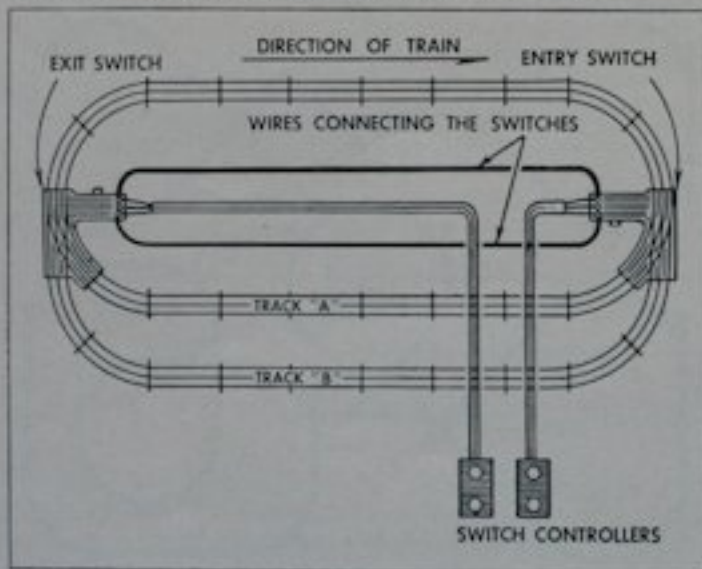

## Controlling Signals with Non-Derailing Mechanism

If a block signal or a semaphore are wired to the switch as shown below they will indicate green "go ahead" when the switch is set for the train to move along the main line and red "stop" when the switch is set for the train to turn into a siding. No. 145 Gateman and No. 445 Switch Tower can also be operated in this way.

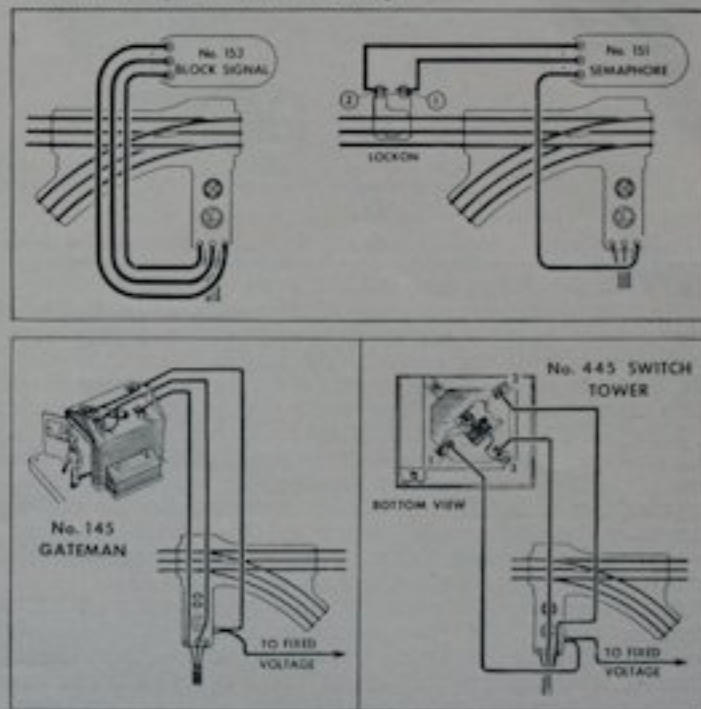



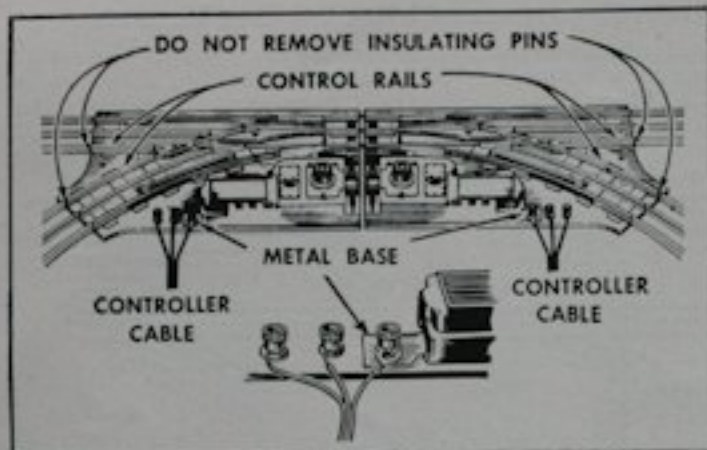

#### No. 1122 Switches for "027" Track

No. 1122 Switches matching "027" track are installed into the track as any ordinary straight and curved sections with each switch replacing one straight and one curved section. No. 1122 Switches have no provision for supplying them with fixed voltage but draw their power from the track.

Like No. 022 Switches, 1122 Switches are equipped with a non-derailing device which automatically throws the swivel rails to the correct position to accommodate an approaching train. These switches are controlled by double controllers which are connected to the switch boxes by 3-wire cables. Connect the wires in order making sure the wire with the lug goes to the post with metal base.

As in the No. 022 switches, the control rails of 1122 switches can be used for automatic operation of signals or for operating several switches simultaneously. Note, however, that the ground post of these switches is the one with metal base and not the center post as in 022 switches.

#### No. 020 and No. 1021 Crossings

No. 020 Crossings which match "O" track and No. 1021 Crossings which match "027" track make possible many unusual track layouts that cannot be achieved with switches alone. Crossings do not require any special electrical connections and are inserted into the layout as any ordinary track sections.

The length of a crossing, however, is not the same as that of a straight piece of track but is designed so that crossings can be used in conjunction with switches to form track "wyes", and "figure 8's", several forms of which are shown below.

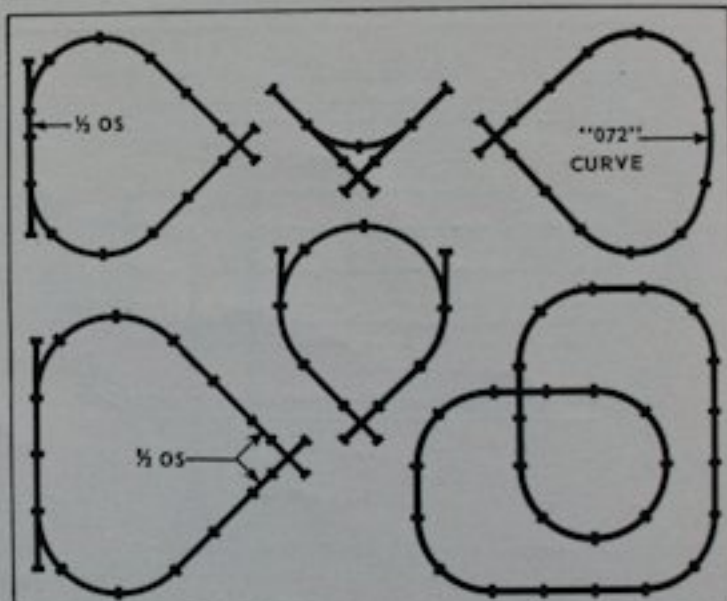

## MULTIPLE TRAIN OPERATION

If you wish to operate two or more trains on the same railroad system, your layout should be designed to prevent one train from overtaking and running into the train ahead.

### One Loop with Insulated Blocks

The first method explained here requires only one track loop in which one or more insulated track blocks are constructed and connected to the transformer through 153C contactors. The contactor is installed several sections away from the insulated block so that the first train passing over the contactor automatically cuts out the power from the insulated block behind it and forces the following train to come to a stop until the first train is safely out of the way. To add interest to this operation a 153 Block Signal or 151 Semaphore can be connected to the 153C Contactor to indicate whether the block is "live" or "dead".

*Note:* When two trains are operated in this way their reversing "E-Units" should be disconnected so that the locomotives do not reverse automatically. For description of a method to preserve automatic reverse see page 31.

An insulated block is made by taking out the metal track pins from the center rail of both end sections of the block and replacing them by insulating fibre pins. The block should be at least 3 track sections long so that the train does not coast through a "dead" block. The contactor should be placed far enough ahead of the block (3 or 4 sections) so that it is not activated by the weight of the waiting train.

In an average-size layout where only one or two blocks are used it is advisable to set the block voltage 2 or 3 volts higher than the rest of the track, so that the waiting train can get a fast start. This is done by using two different transformer circuits having a common "ground" post connected to the outside rail of the rail system. See page 43.

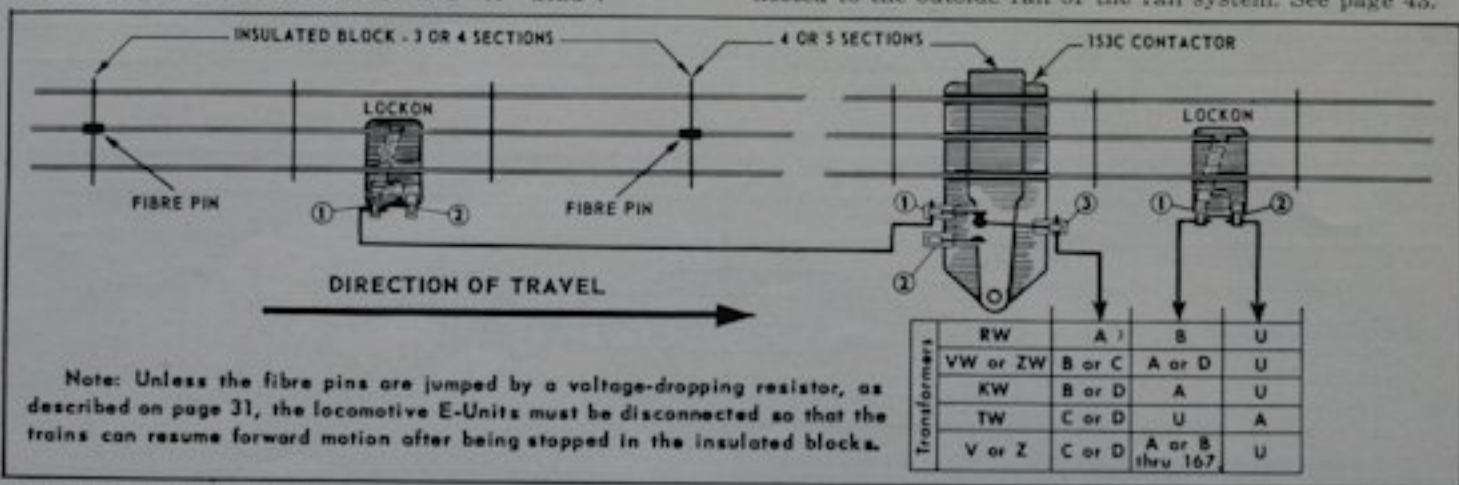

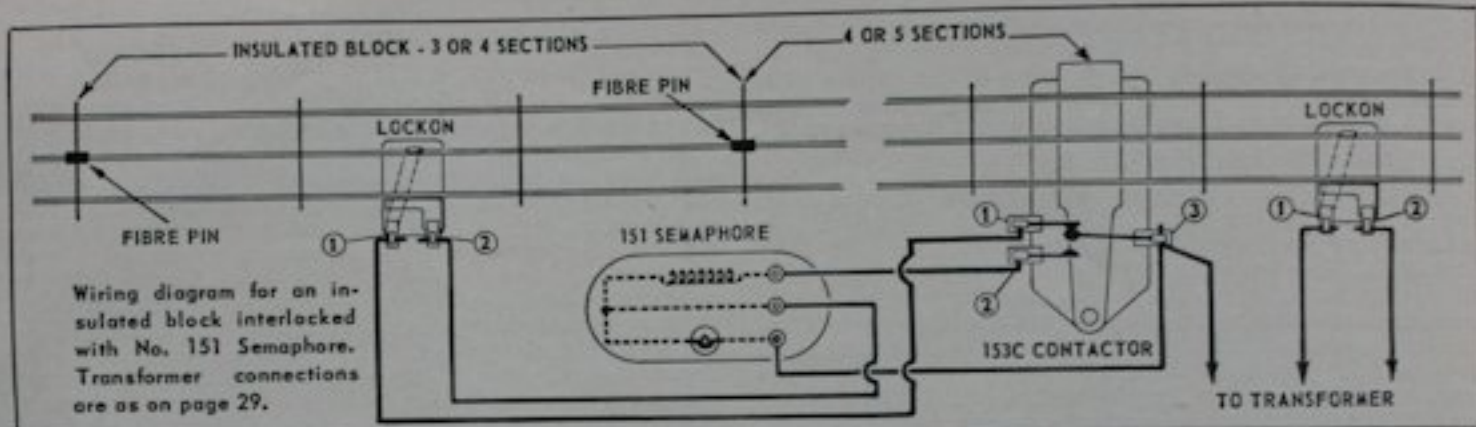

When running two trains on the same layout it is important that they operate on approximately the same voltage, or the faster train will tend to catch up with the slower

train before reaching the insulated block. Some of the variation in the speed of the two locomotives can be compensated by loading down the speedier train.

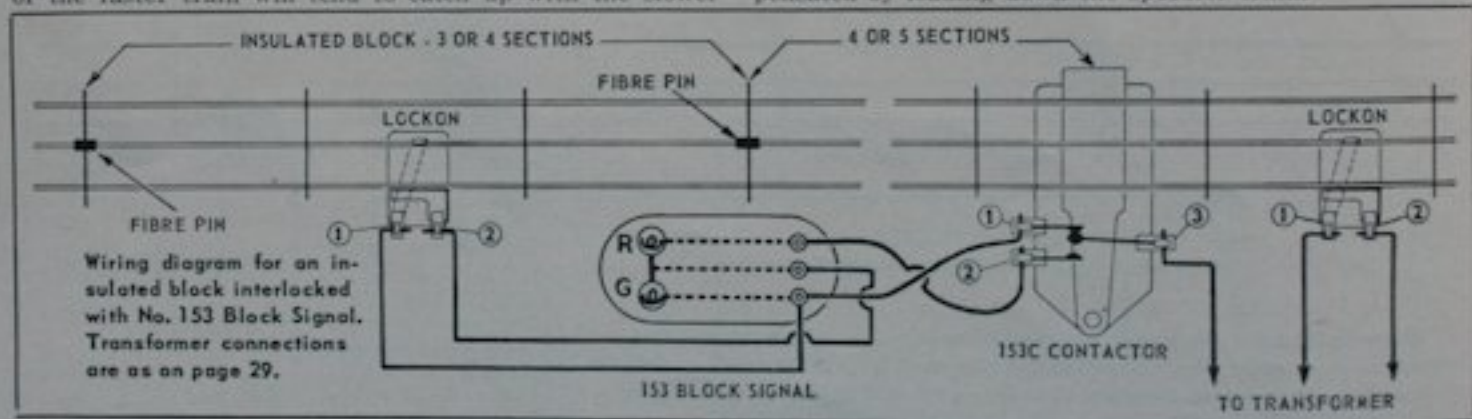



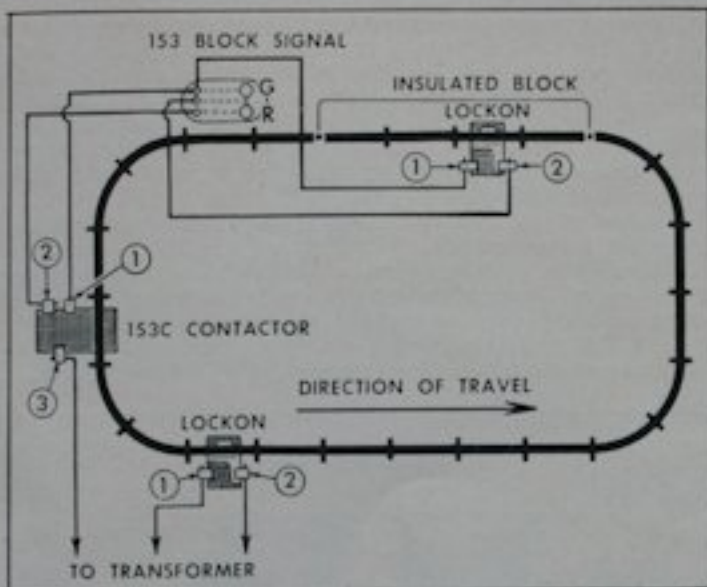

In the oval layout above, the insulated block is normally "live" so that both trains operate continuously unless the second train gets too close to the first train. When this happens the second train stops in the block until the first train pulls far enough ahead. The Block Signal indication is normally green.

In "figure 8" layout on the right the insulated block is wired to the contactor so that it is normally "dead". This forces the train reaching the block in front of the crossing to stop and wait until the other train crosses in front of it. The signal is red, changing to green only when the moving train reaches the contactor.

**"Wipe Your Track Regularly"**

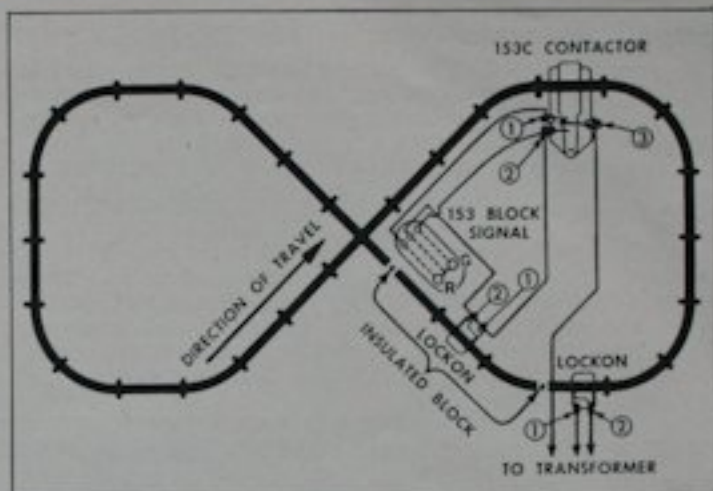

### Preserving Reversing with Insulated Blocks

A scheme which is sometimes used in large layouts to preserve the reversing feature of the locomotives even though insulated blocks are used, is to "jump" the fibre pin into each block with a 10-ohm 10-watt adjustable resistor available at radio and television supply stores. The resistor is then adjusted to permit just enough current to leak into the insulated block to keep the reversing unit energized but not enough to operate the motor. With this installation the blocks have to be somewhat longer.

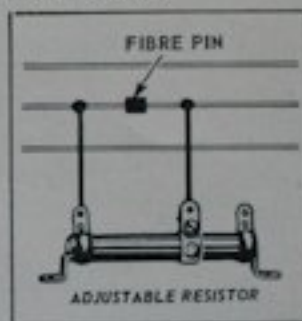

## Separate Insulated Loops

A second method for running several trains on the same railroad system is to arrange two or more complete loops insulated from each other by means of a fibre pin in the center rail of the track line connecting the two loops. In this system the center rail of each loop is connected to an individually controlled track voltage so that each of the trains can be controlled without interfering with the others.

An "O" layout of this type, designed to fit on a 4' by 8' platform and suitable for operating as many as three trains, is illustrated below. Note that in addition to the two insulated loops this layout contains two insulated blocks, one located in the connecting track on the right, and one in the right hand portion of the inner loop.

The block in the connecting track can be used as a siding to hold a train while two other trains run in the inner and outer loops. The block in the inner loop is used to hold a train while another train enters into the left half of that loop. The power to the two insulated blocks is controlled by a pair of No. 364C controllers or any off-on switches which are available in hardware or electrical supply stores and from radio and television supply mail order houses.

If desired, the insulated block in the inner loop can be connected for automatic control through a 153C contactor as described in previous section and another similar automatic control block added in the outer section as well, to permit collision-free operation of two trains in either loop. A double-throw switch may be provided to switch from manual to automatic operation, as "S2" on page 35.

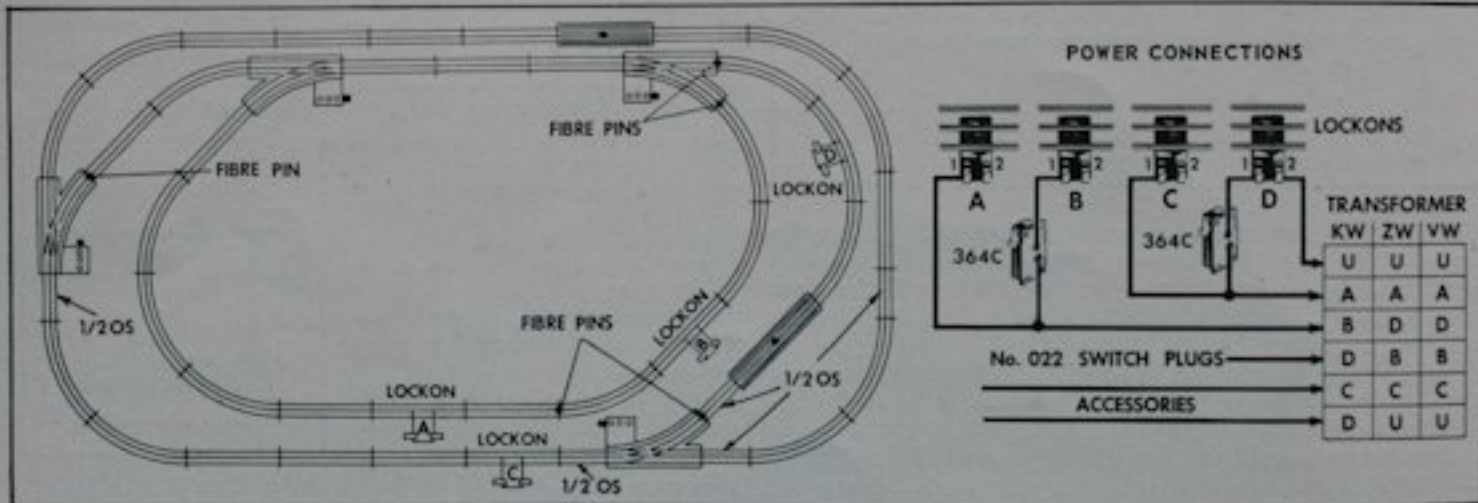

The "O" layout on this page is designed to fit on a standard ping-pong table which measures 5 feet by 9 feet. Like the layout on the preceding page it is sectionalized by the insertion of insulating pins at points indicated by arrows.

Two trains can run continuously and be independently controlled on the track loops fed through lockons A and C. There are also two freight sidings supplied through lock-

ons D and E and a block connecting the two main loops and supplied through lockon B. The two sidings and the connecting track are wired through off-on switches so that a train can be halted in any of these locations.

Note that the addition of a curved section and a left-hand switch at the end of the siding D can convert this siding to a reversing loop enabling a train to change its direction.

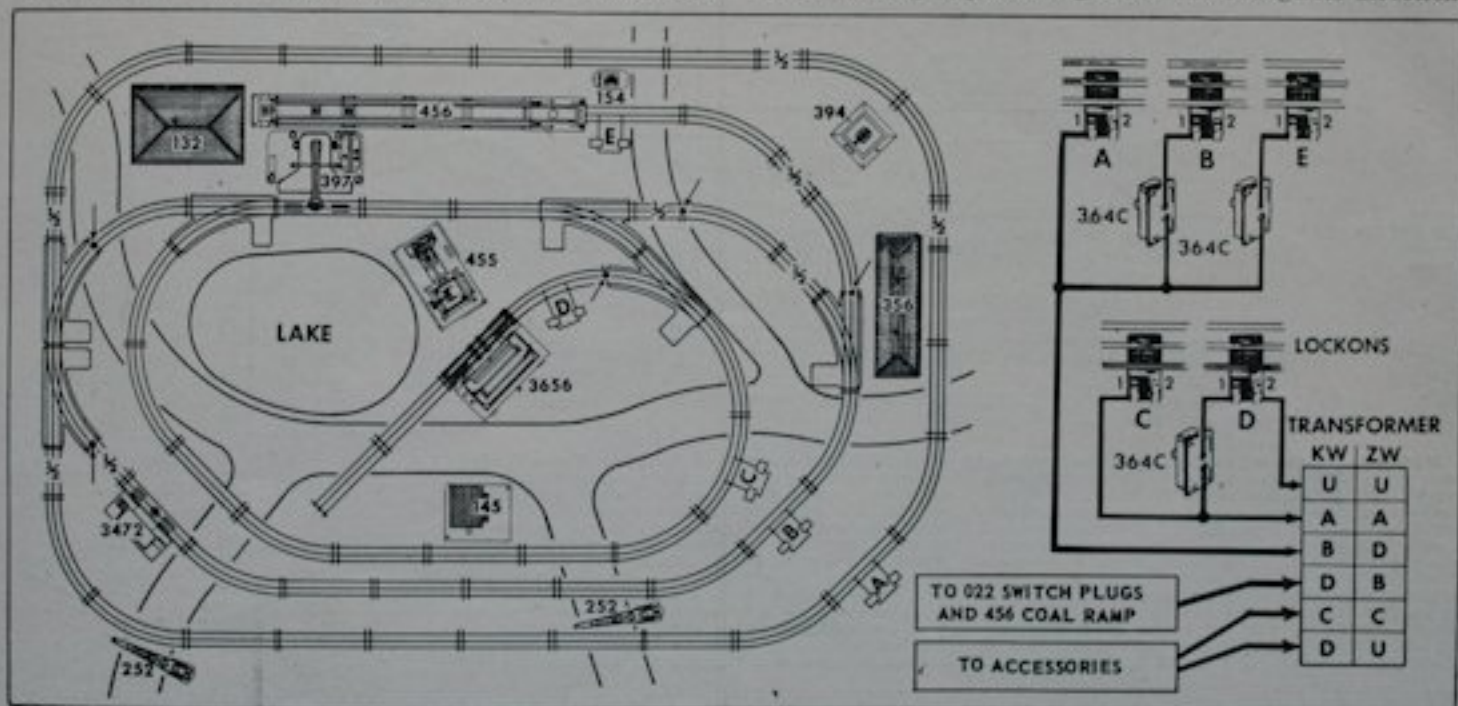



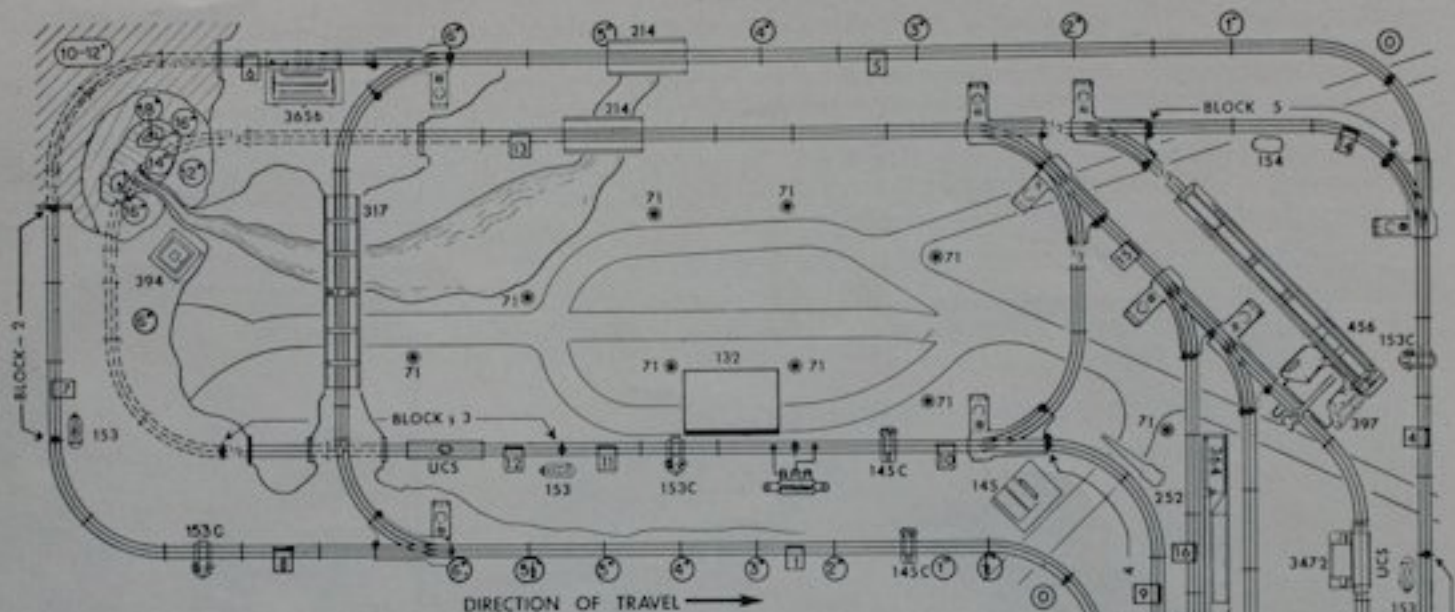

Block dots are insulating track pins. The insulating pins in No. 522 switches are also shown in the same way. Circled dimensions show the height of various portions of track and scenery. Follow these dimensions carefully, particularly in the upgrade and downgrade portions of track. Numbered rectangles are track lockers, or soldered track connections. Blocks 1, 2 and 3 are used to prevent rear-end collisions when two trains are operated on the same track oval. These blocks can be thrown in or out of the circuit at will by means of double-throw switches marked "S2" in the wiring diagram on the right. Blocks 4 and 5 guard against accidental

crossovers from one oval to the other. These blocks, as well as all of the sidings, are insulated and individually controlled by single-throw switches marked "S". The adjustable resistor shown in the plan and in the wiring diagram is necessary at that point to obtain an additional source of low voltage for the downgrade section. Similar resistors can be installed at each track block to preserve the reversing function of locomotives even though they are operated with an automatic block system. Their use, however, would require somewhat longer blocks to allow for the longer coasting of the locomotives. See page 31 for specification of the adjustable resistors.

The L-shaped layout on the opposite page is designed in "O" track for operating two or more trains and has several interesting features including a graded portion, a freight yard and a block system. As illustrated, this layout requires an area of about  $15\frac{1}{2} \times 5\frac{1}{2}$  feet for the main section with a 3 x 4 foot extension for the freight yard, but, of course, the dimensions can be altered to suit the available area.

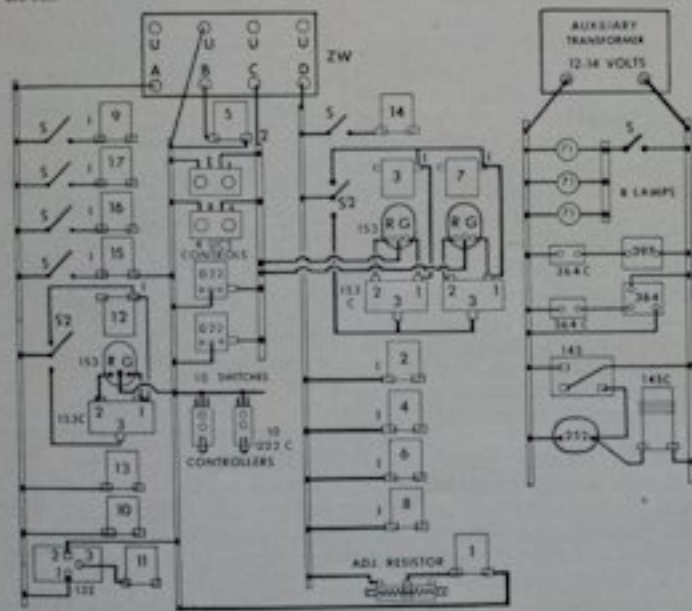

Wiring Diagram of Layout at Left. Note how the ground and power leads of UCS and 222C controllers are connected directly to bus bars. This shortens the length of wired connections and reduces voltage losses. Note also that the street lights and operating accessories are powered by an auxiliary transformer and that the lights are controlled by a separate switch.

"Wipe Your Track Regularly"

## Use of Relays

While 145C and 153C contactors are simplest to install in any temporary or semi-permanent layout, many model railroaders who build permanent landscaped layouts prefer to use relays instead of contactors for block operation, automatic signaling, etc. Once installed, relays do not have to be adjusted and do not depend on the weight of the train.

Relays suitable for model railroading are not available from Lionel but generally sold by distributors of radio and television parts, many of whom also sell by mail.

Of the several makes available, the most suitable are: Potter & Brumfield MR Series and Guardian Series 200, both with 12 volt a.c. coils. The cost of these relays generally ranges from approximately \$2.00 to \$4.00, depending on the contact arrangement desired.

Relays are installed in conjunction with insulated rails, as shown below, so that the wheels of a train reaching this control rail energize the relay coil and open and close the various relay contacts which can be made to operate signals, switch off or switch on power going to insulated blocks, etc.

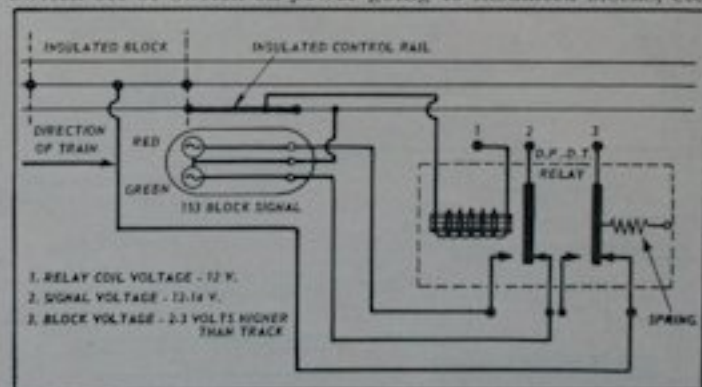

## WORKING WITH LIONEL TRACK

Lionel track is made in two different sizes: "O" and the lighter "027". The quickest way to tell the difference between them is by the shape of the track ties. Although the track "gauge"—the distance between the outside rails—is the same for both types of track— $1\frac{1}{4}$  inches—"O" and "027" track should not be used in the same layout because of a  $\frac{1}{4}$  inch difference in the height of the track and the difference in the diameter of the rails.

Wide-radius "072" curved track, illustrated below, matches the regular "O" track and is very useful for constructing wide, sweeping curves especially suitable for the longer locomotives and streamlined pullman cars. Wide radius track is sold in boxes of 16 track sections which is enough to form one complete circle.

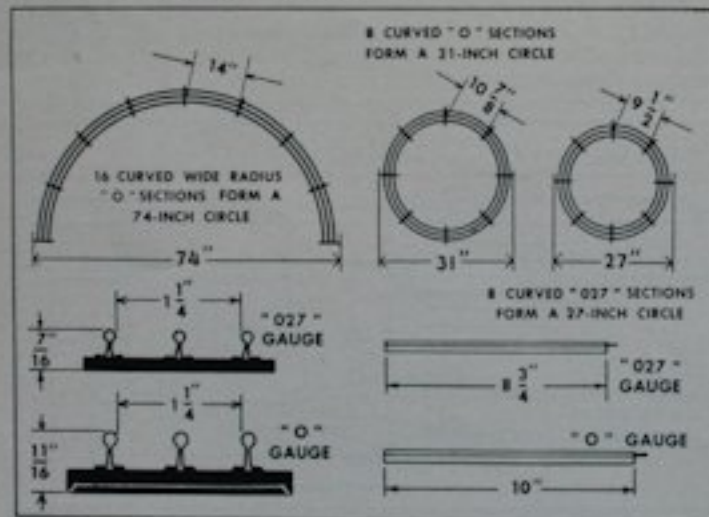

In addition to the regular length "O" track Lionel makes half-sections, known as  $\frac{1}{2}$  OS (straight) and  $\frac{1}{2}$  OC (curved) which are useful for many types of layouts. If the half-sections are not available, or if you need special lengths, it is possible to cut the regular track to the desired lengths. Clamp a track section in a vise using padding to protect the rails from being crushed and cut the rails with a jeweler's saw or a fine-toothed hack saw. Smooth the cut edge with a fine file.

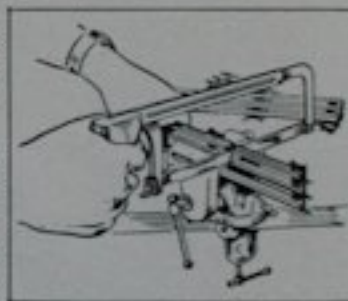
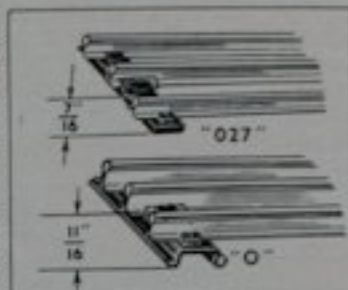

Lionel track is somewhat flexible so that it is possible to construct layouts which are not strictly symmetrical. However, be careful not to distort the layouts too much or you may cause the train to derail.

### How to Mount Track on a Platform

If you mount your track on a plywood board or platform your train operation will be smoother and your track will last longer. For fastening track to platform use one No. 3 x  $\frac{1}{2}$ " round head wood screw to each section of "O" track; "027" track requires No. 2 x  $\frac{3}{8}$ " screws. Don't screw down the track tightly or you may distort the track ties causing a "wavy" track. Track should not be clamped down but fastened only enough to keep it from shifting its position. A sheet of "Celotex" or similar material may be placed on top of the plywood to sound-proof the layout.



## Lionel Track Pliers

When working with Lionel track it is frequently necessary to remove track pins in order to move them to the opposite end of the rails, to replace steel pins with insulating pins, and to reshape distorted or enlarged rail openings.

All these jobs, including cutting and stripping of connecting wires, can be accomplished quickly and easily with special Lionel Service Track Pliers recently designed by Lionel and now available to model railroaders by mail from the Lionel Service Department for \$2.95. The pliers are made in two sizes: No. ST-342 for "027" track and No. ST-343 for "O" track. Top picture shows how the plier jaws are shaped to round the rail and to crimp pins tightly in the rails.

To pull out track pins grip the pin with the cutting edge and pry it out, using the rail flange as point of rotation.

To reshape a distorted rail insert it into the forming hole of the pliers and squeeze it into shape. Doing this before the pin is inserted will result in a tighter-fitting pin.

To crimp a pin in the rail, insert the pin to the proper depth, line up the little projections in the plier jaws with the groove in the pin and squeeze.

## Insulated Track Sections

Special track sections which have one insulated outside rail are frequently used by model railroaders in permanent layouts instead of 145C and 153C contractors to accomplish automatic operation of semaphores, block signals, gatemen and other track accessories. Several applications of these track sections are illustrated on pages 38 and 39.

Although these sections have not been manufactured recently they are still available at some Lionel dealers or can be easily made from regular track, as illustrated below. Remove one outside rail, insert pieces of adhesive tape inside the clips of the track tie and replace the rail, bending down the track tie clips tightly. To complete the insulation of this rail fibre pins are inserted in both ends of the rail. Connections to it can easily be made by means of a track lockon attached on the side of the insulated rail. No. 2 lockon clip will then be connected to the insulated rail.

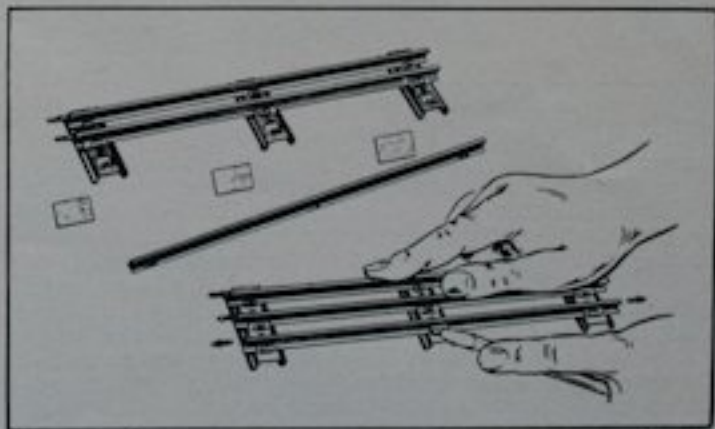
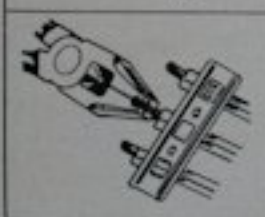
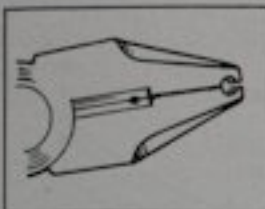

## Automatic Control of Accessories

The use of insulated track sections to control signals and accessories is shown on this page. When properly connected to the transformer and to the insulated rail, the accessories will operate when the wheels and axles of a train passing over the special track section complete the electrical circuit by bridging the insulated rail to the "grounded" opposite outside rail.

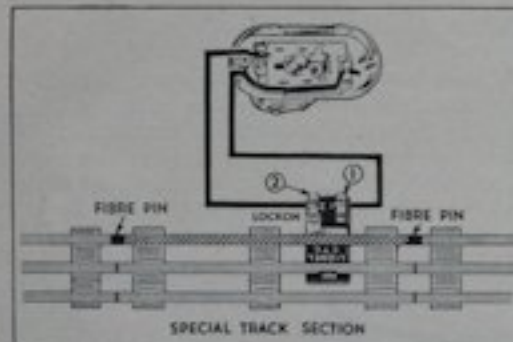

Left: No. 252 Crossing Gate Operated by an Insulated Track Section. No. 140 Banjo Signal Can Be Operated in the Same Way.

Right Top: Insulated Track Section Used for Automatic Control of Switches.

Right Bottom: No. 145 Gateman Operated by Insulated Track Section.

The method used for controlling No. 145 Gateman can be used as well for No. 151 Semaphore and No. 445 Switch Tower. In the case of No. 151 Semaphore the center post is connected to the transformer, the outside post which lights the lamp is connected to No. 2 clip of the lockon outside the insulated track and the post operating the semaphore arm to No. 2 clip of the lockon on the insulated track.

To operate the Switch Tower its No. 2 clip is connected to the transformer, No. 3 clip to lockon outside the insulated track and No. 1 clip to the lockon on the insulated track.

Of course, if you wish the train to operate several of these accessories simultaneously all of them can be connected to the same insulated track section.

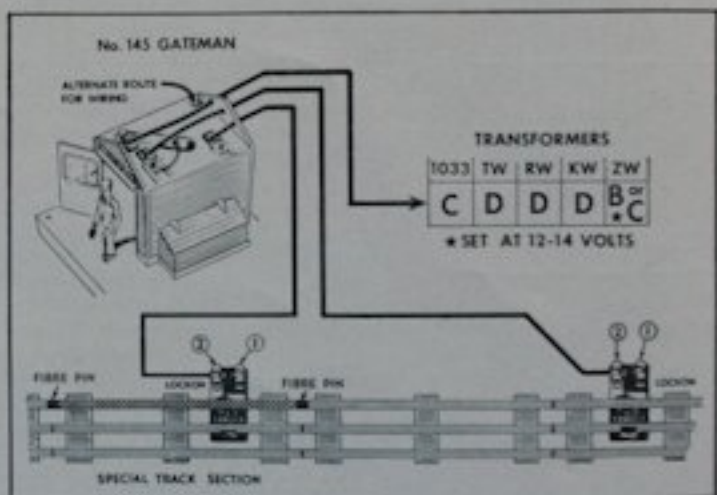
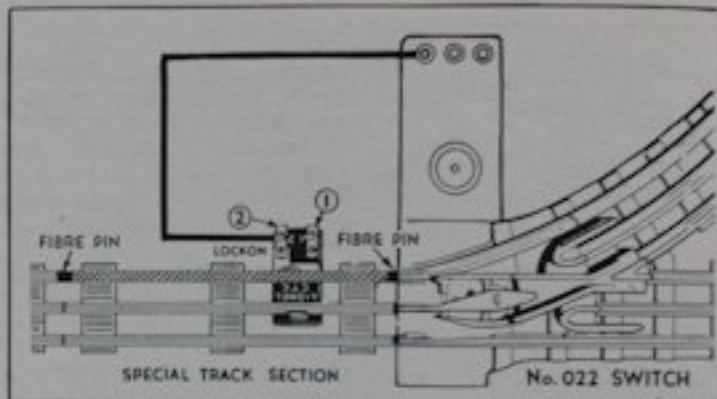

## Automatic Control of Trains

Insulated rails can also be used for automatic control of trains so that two trains can be run on the same layout, even in opposite directions, never colliding. Two such layouts are illustrated on this page. To accomplish this kind of operation an insulated block "A" is installed in each of the passing sidings by inserting insulating pins in the outside or "ground" rails rather than in the center rail. A train reaching those blocks will lose "ground" and stop. Control blocks "C", made up of track sections having one insulated rail (shown by a heavier line) is installed so that this insulated rail is connected to one of the outside rails of blocks "A". As soon as a second train reaches a control block its wheels and axles ground the control rail and so

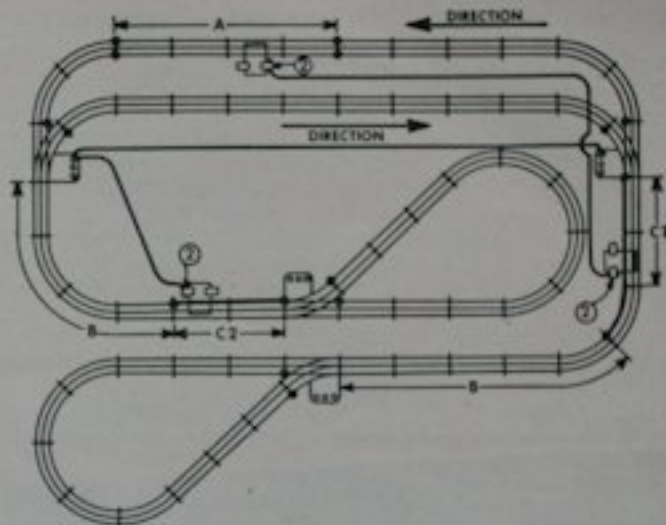
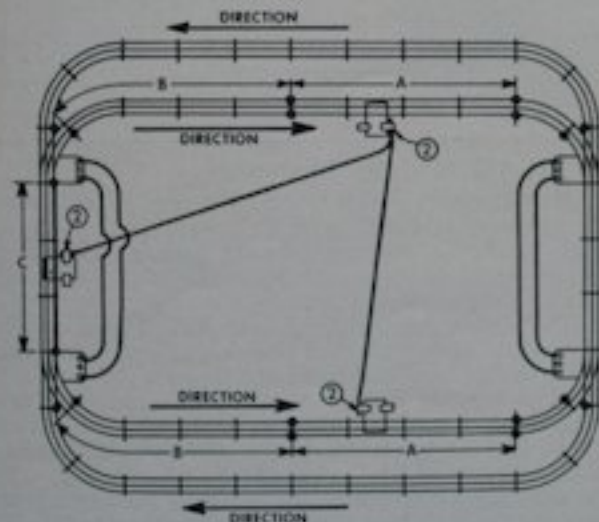

complete the circuit for the waiting train enabling it to start and pull out of the siding. Note that in the layout on the right a similar control section "C2" is provided to control the position of the switches. On the layout on the left the switches are interconnected to control each other as described on page 27.

If desired, a similar operation can be accomplished through the use of 153C pressure-type controllers instead of insulated rails. In this case, however, the center rail rather than the ground rails must be insulated. Also this type of control offers an opportunity of supplying the insulated blocks with voltage 2 or 3 volts higher than the rest of the track in order to give the waiting train a fast start.



## SPECIAL INSTALLATIONS AND CONTROLS

### Fixed Voltage for Remote Control Sections

Although in standard installations the control rails and electro-magnet of remote control sections get their power from the track it is sometimes desirable to provide them with fixed voltage. This makes the uncoupling and unloading functions independent of variable track voltage. Disconnect the power wire from the remote control track and connect it instead directly to the proper transformer post. In working with the flat multi-conductor cable be careful to keep it flat so as not to interchange the connections.

To shorten the wiring, particularly when the controllers are located together on one control board, the number 1 wire of the cable can be disconnected from the remote control track and connected instead to the "ground" terminal of the transformer. See wiring diagram on page 35.

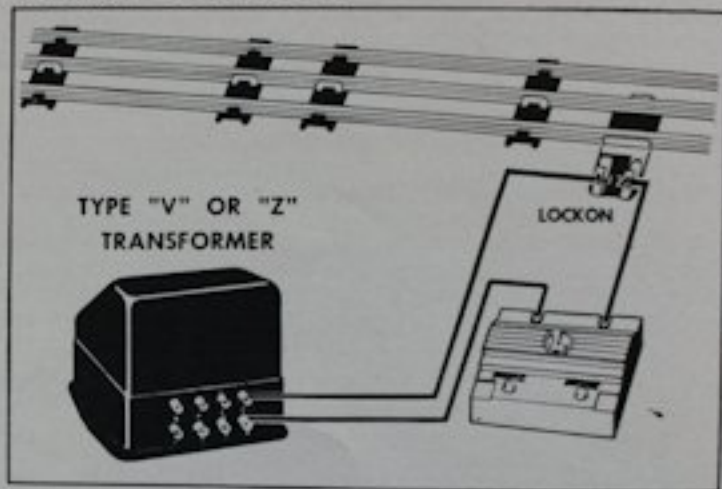

### Use of No. 167 Whistle Controller

No. 167 Whistle Controller must be used in conjunction with transformers which do not have a built-in whistle controller. When No. 167 controller is used, one of its posts must be connected to the No. 2 clip of the track lockon while the other is connected to the proper transformer post.

Type ZW transformers have two built-in whistle controllers so that the whistles of two trains can be controlled independently. If you are running more than two trains and wish to provide independent whistle control for the extra trains as well you must provide No. 167 Whistle Controllers for the two circuits (posts B and C) which do not have built-in whistle controllers. Because of voltage drop in the 167 Controllers the voltage setting of these circuits must be 2-3 volts higher than ordinarily.

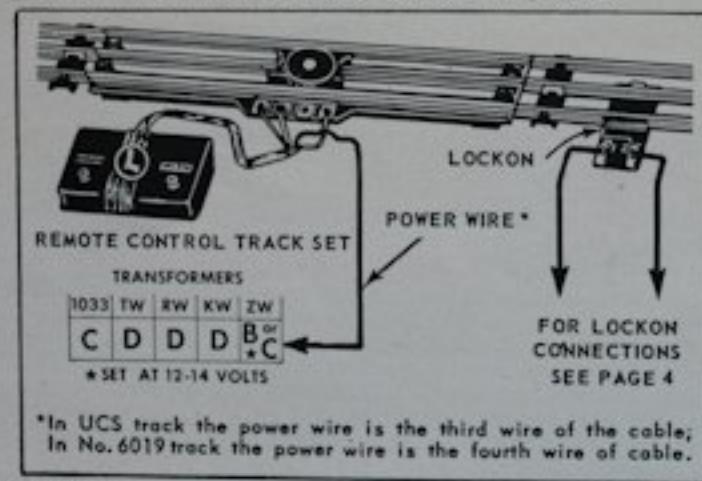

## ABOUT YOUR POWER SUPPLY

A few words about electricity may help you understand some of the electrical terms which are used in describing the operation and requirements of your Lionel electric trains, transformers and other equipment.

The three most commonly used electric units of measurement are amperes, volts and watts.

*Amperes* are used to measure the quantity of electric current flowing through a circuit.

*Volts* are used to measure electric pressure.

*Watts* are used to measure electric power. For the purposes of rough estimates in alternating current circuits they can be calculated by multiplying amperes by volts.

If you compare the flow of electricity to the flow of water from a squirt gun you can see that the more pressure you put on by squeezing the trigger the faster will be the water jet, and the more water you will be able to get out of the muzzle opening.

In the same way increasing the voltage will send more electric current through the wires and the motor. With the pressure or voltage kept even, the amount of current—either water or electric—that will flow through the system naturally depends on the size of the opening, or the thickness of the wires used in the circuit.

### Alternating and Direct Current

Two terms that are used very often to describe electric current are Alternating Current (A.C.) and Direct Current (D.C.). Direct current is the kind that flows in one direction only—from Positive (+) to Negative (-). This is the kind you obtain from electric batteries. Alternating current is produced by electric generators and changes the direction of its flow many times a second according to its frequency (CYCLES). This is the usual type of current used in your house mains. The house electric supply generally used in the United States is 115-volt, 60-cycle alternating current. Some parts of California use 50-cycle

current; some areas in Canada and upper New York State use 25-cycle current; while some downtown areas in New York City still use 115-volt Direct Current (D.C.).

A transformer should never be plugged into a Direct Current line or it will either burn out itself or blow out the fuse.

High voltage Direct Current requires the use of an *inverter*, which changes direct current into alternating current. The inverter is first plugged into the wall outlet; the transformer is then plugged into the inverter. Lionel has not made inverters since the war, but they are readily available elsewhere.

### What a Transformer Does

Because 115-volt line voltage is dangerous to use in toys, Lionel Trains are made to run on low, completely safe voltage ranging from 8 volts to 25 volts, depending on the type and size of the locomotive. This low voltage must be obtained from a step-down transformer which changes your household voltage to the low safe voltage.

The transformer basically consists of two coils of insulated copper wire, each separated from the other but wound around a common core of electrical steel. One of the coils—the primary—is wound with many turns of fine wire and is connected to the household electric outlet. The other coil—the secondary—is wound with fewer turns (approximately 1/5) of heavier wire.

When the primary coil is plugged into an A.C. household line, the alternations of the primary voltage are reflected in the secondary coil and induce a low secondary coil voltage used to run the train and accessories.

Because the secondary voltage is reduced from the primary in the same ratio that the number of turns in the secondary winding has to the turns in the primary winding, a provision is usually made to "tap" the secondary winding at several points so that several different "fixed" voltages can be obtained.

In addition, Lionel transformers have a movable contact arm which slides across the bared surface of a portion of the secondary winding. This makes it possible to "tap" the secondary winding at any turn of wire and provides the means for obtaining a smoothly variable voltage used for accurate control of train speed without the use of resistors, rheostats or other voltage-dropping devices.

### What Causes Voltage Drop

The "fixed" voltages marked on your transformer panel or the voltages indicated by your transformer voltage control at any particular setting are almost never the actual voltages delivered to your track or your accessories. The reasons for this variation are several. The voltages marked on your transformers are "nominal". That is, they are accurate only under certain specified conditions: when the line voltage fed into a 115-volt transformer is just 115 volts and when *no current is drawn* from the transformer. Actually, the line voltages may vary from 125 to 110 volts, or even lower, depending on the standards in your locality and on how much electricity is being used at a particular time. This variation, normally, results in the same percentage reduction of the output voltage of the transformer. If your train seems to run slower toward the evening it's probably because hundreds of people in your neighborhood had switched on their lights and household appliances and so depressed the line voltage.

In the same way that a heavy demand for power may lower the voltage in your neighborhood, a heavy load on your transformer lowers its output voltage as well. For example, the fixed binding posts which are marked 14 volts may, under actual operating conditions, deliver only 12 volts, or even less. In the case of a severe overload such as caused by a short circuit on the track so much current is drawn from the transformer that its voltage drops to 2 or 3 volts—too low to operate the train or even light the lamps.

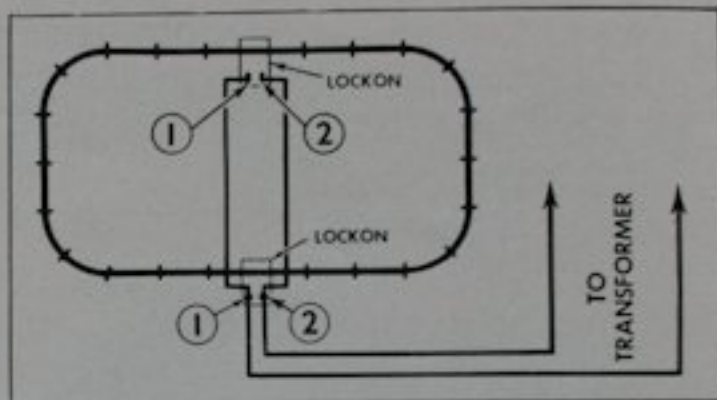

### Using Auxiliary Lockons

In operating large layouts it is frequently found that the train slows down when running on the portion of track farthest from the Lockon. This is due to voltage losses in the track itself and can be remedied by attaching additional Lockons at the points on the track where the train slows down. Be careful to connect the No. 1 and No. 2 clips of the auxiliary Lockons to similarly numbered clips of the Lockon connected to the transformer to avoid a short circuit.

The main part of voltage losses in the track is due to loose track pins. These loose connections can be frequently detected by the heating effect of poor electrical contacts. After the layout has been in operation for a half hour or so, run your finger down the rails. Loose rail joints will then become apparent as hot spots on the track.

In large permanent model railroads short copper wire "jumpers" are frequently soldered across the track pins to eliminate all possible track voltage losses and keep the voltage constant all around the track system.



### Circuits with Common Ground

In model railroading there are numerous occasions when it is desirable to apply different voltages to accessories or track components which have a common "ground" with the rails of the track system. Examples of this usage are fixed voltage plugs of No. 022 switches, remote control track sections operating on fixed voltage, insulated track blocks used in multiple train operation, upgrade or downgrade portions of track requiring higher or lower voltage than level track, No. 456 Coal Ramp, etc.

To prevent short circuit condition in all such cases it is important to select transformer circuits which also have a common ground. The chart below lists various circuit combinations which are available in modern Lionel transformers. The voltages specified are the nominal or "no load" voltages and will, of course, drop somewhat under operating conditions, depending on the load and the rated wattage of the transformer.

Transformer	With this as Common or Ground Post	These are the Fixed Voltage Posts	And these are the Variable Voltage Posts
1032, 1033 Multi-Control	A	C 16 V. B 5 V.	U 5-16 V.
	B	C 11 V.	U 0-11 V.
	C	A 16 V. B 11 V.	None
	U	None	A 5-16 V. B 0-11 V.
"KW" Multi-Control	U	D 20 V. C 6 V.	A 6-20 V. B 6-20 V.
	C	D 14 V. U 6 V.	A 0-14 V. B 0-14 V.
"VW" "ZW" Multi-Control	U	None * With Internal Whistle Control	A* 6-20 V. B 6-20 V. C 6-20 V. D* 6-20 V.

"RW" Multi-Control	A	D 19 V. C 9 V.	U 9-19 V.
	B	D 16 V. C 6 V.	U 6-16 V.
	D	A 19 V. B 16 V. C 10 V.	None
	U	None	A 9-19 V. B 6-16 V.
"TW" Multi-Control	A	C 18 V. D 14 V. B 7 V.	U 7-18
	B	A 7 V.	U 0-11
In addition this transformer has 2 posts marked E and F which furnish an independent 14 V source to supply lights, accessories, etc.			

The following table lists the fixed voltage circuits which can be obtained from some of the most popular Lionel transformers made in recent years.

"A", "Q"	A	C 14 V. B 8 V.	U 14-24 V.
	B	A 8 V. C 6 V.	U 6-16 V.
	U	None	A 14-24 V. B 6-16 V.
"R"	A	D 14 V. B 8 V.	C 14-24 V. F 14-24 V.
	B	E 16 V. A 8 V.	C 6-16 V. F 6-16 V.
	D	A 14 V. E 10 V.	None
"V" "Z"	U	None	A 6-25 V. B 6-25 V. C 6-25 V. D 6-25 V.



### Transformer Rating

Regular Lionel transformers are designed to work on 110 to 125 volt, 60-cycle alternating current. Other combinations of voltage and frequency (cycles) require special transformers, which are generally available from Lionel dealers located in areas having these special conditions. The voltage and

frequency ratings of transformers always appear on the transformer panels. Transformers can be operated on frequencies which are higher than their rated frequencies (a 25-cycle transformer will operate on 60 cycles, for example), but the reverse of this is not true. If a 60-cycle transformer is plugged into a 50-cycle or a 25-cycle line it will overheat and may be seriously damaged.

### About Wattage

In addition to their voltage and frequency ratings, transformers and other electrical equipment also bear a wattage rating. The wattage of a toy transformer is a measure of the maximum amount of electric power which it can take from the household power lines without overheating.

The thing to remember is this: You have no control over the *voltage* and *frequency* rating of the transformer you need because that is determined by the available household current supply. You do have control over the *wattage* rating of the transformer you select. In this selection you must be guided by the size of your railroad system and the number of trains, lights and accessories you will use.

*It is always wisest to get a transformer larger than the one you require for your immediate needs in order to provide power for future expansion.*

### Power Requirements of Lionel Equipment

The following table lists the power in watts used by various model railroad equipment.

Item	Watts
"027" Locomotive—no Whistle	15-25
"027" Locomotive—plus Whistle	25-35
"O" Locomotive—no Whistle	20-25
"O" Locomotive—plus Whistle	30-35
"O" Locomotive with Smoke and Whistle	35-40
No. 167 Whistle Controller	5-10
Automatic Accessories	12-15
Operating Accessories	10-25
Each 6-Volt Lamp	1½
Each 12-Volt Lamp (small)	2
Each 12-Volt Lamp (large)	3
Each 18-Volt Lamp	5

*Note:* The voltage of various lamps in Lionel equipment is listed on the inside of the back cover.

You do not need to figure in the power requirements of automatic couplers and operating cars, since the couplers draw current for only an instant and operating cars only when the train is not running. For the same reason, do not add power used by such accessories as the coal elevators, log loaders, and other operating devices which are put in action when the train is not running.

However, accessory lights and equipment containing steadily-burning lamps (as, for example, switches and switch controllers) use more power and should be added into the power needs. Don't forget to add in the power used by lamps within the cars, particularly in passenger sets.

If, for example, the total power needs of a train set and accessories come to 90 watts, a type RW transformer (110 watts) may be used. However, this power would be close to the maximum for the RW and would not allow for additional accessories. While another transformer can be purchased solely for operating the accessories, it is more economical in the long run to get a 275-watt ZW transformer initially.

## How to Estimate Available Power

As stated before, the wattage rating of a transformer tells you how much power it will take from your household mains. However, all of this power is not available for your train. From about one-quarter to one-eighth of the total wattage taken from the lines is used up by the transformer itself in transforming the power from high to low voltage. This wattage loss becomes apparent in the warming up of the transformer as it is used.

A transformer operating continuously for long periods of time or in warm surroundings will be able to deliver less power than one used intermittently or in cool surroundings. As the transformer warms up in use its output voltage and wattage will drop gradually.

As an example, a 90-watt No. 1033 transformer should not be used to deliver more than 60 watts of usable low-voltage power. A 275-watt ZW transformer should not be counted on to supply more than 200 watts. It is important to take this loss into consideration when estimating the amount of equipment your transformer can operate.

Table for Selection of Transformers

Transformer	Capacity	Recommended for Operating the Following
1033	90 watts	One "027" outfit with smoke and whistle; few track or signal accessories.
RW	110 watts	Any "O" outfit with smoke and whistle; few switches and other accessories.
TW	175 watts	Any "O" outfit with a considerable number of accessories.
KW	190 watts	Two "O" outfits with smoke, whistle, switches and other accessories.
ZW	275 watts	Any practical railroad system with two or more trains, etc.

## How to Connect Transformers in "Parallel"

When the power requirements of a model railroad are so large that more than one transformer is needed, the best practice is to use one transformer to furnish variable voltage for the track and reserve other transformer for lights and accessories. In some cases, however, when several trains are operated at the same time in various insulated sections of system, it might be necessary to use more than one transformer for the track itself.

To connect two transformers to the track they must be properly "phased" so that the high and low peaks of their alternations coincide. If they do not, a short circuit will be created whenever locomotive contact rollers bridge across a fibre pin separating two insulated portions of track.

To "phase" two transformers proceed as follows: Connect the "U" binding post from each transformer to the No. 1 clip of a lockon attached to a piece of track. Set the output voltages of the two transformers at the same point and plug the transformer cords into a wall outlet. Then touch together a pair of wires leading from the "A" binding posts. If you get a strong spark indicating a short circuit *reverse the plug of one of the transformers*. Once you have determined the correct position of the two plugs mark them in some way so that you will be able to connect them correctly in the future. You can connect the two transformer cords permanently by wiring them to the same plug.

When the transformers are in phase their ground or common posts can be connected to the outside ground rail, and the available voltage circuits used to supply several different voltages required by the various insulated portions of the center power rail.

Even when the transformers are in phase, however, you must be careful to set the voltage of the two adjacent sections at approximately the same point when transferring a locomotive slowly from one circuit to the other. Otherwise its rollers may bridge the insulating pin long enough so that the partial short created at that moment will stop the locomotive.



## HOW TO BUILD A MODEL RAILROAD

One of the most fascinating things about owning a miniature train is the planning and building of a model layout that has all the features of an actual railroad system. With Lionel's wide selection of tracks and accessories it is easy to duplicate any of the operations of the big roads. Like all hobbies, model railroading develops slowly. You can start with a layout that fits your income, and add to it gradually.

This booklet has a few ideas to get you started. You can get a great many more from "Model Railroading", a 384-page Bantam Book which is available for 50 cents at your newsdealer or from the Lionel Advertising Department.

### Plan Your Layout Carefully

First step is to get out your pencil and put down a few ideas that will guide you in your planning. Where will your

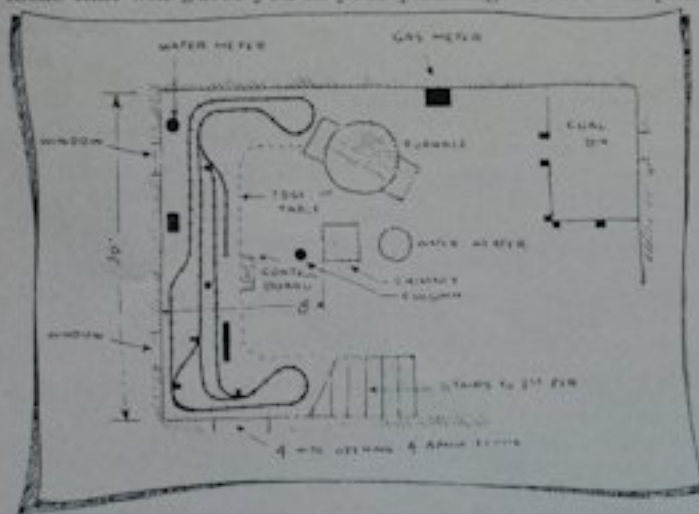

Overall size: 82" x 32".  
Track needed: 8 sections  
straight, 10 sections curved,  
pair of switches.

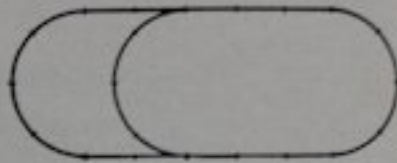

Overall size: 82" x 41".  
Track needed: 14 sections  
straight, 8 curved, 3 switches  
1 remote control section.

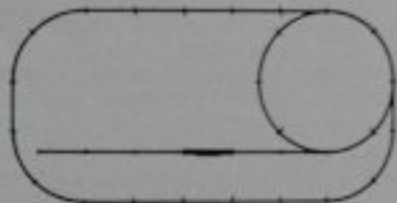

Overall size: 82" x 41".  
Track needed: 15 sections  
straight, 14 sections curved,  
one 90 degree crossing, one  
remote control section.

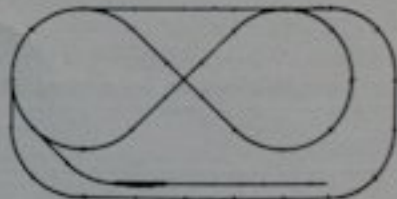

Overall size: 82" x 41".  
Track needed: 14 sections  
straight, 10 sections curved,  
4 switches, 2 remote control  
sections.

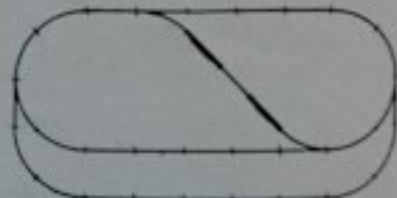

Here are a few of the simpler layouts. These are in "O" track. Similar "D27" layouts will be ten percent smaller.

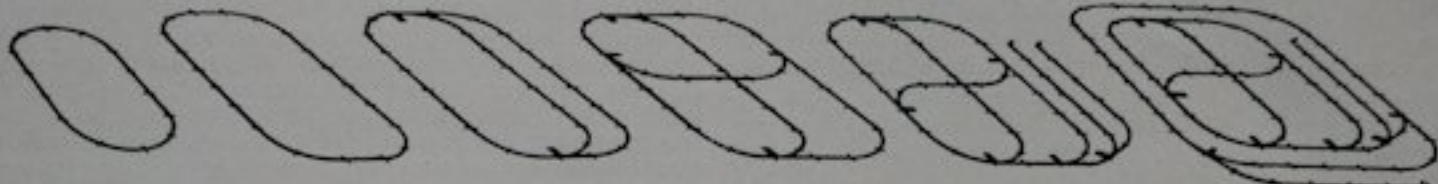

This is the approximate layout you get with the Lionel outfit you buy.

Add a few straight sections to get ready for a really big operation.

To get a passing siding add 2 switches, 2 curved, 3 straights.

Two more switches, one crossing and 2 curved sections give you this.

One curve, 7 straights, 2 more switches provide a classification yard.

Another set of switches, 7 straights, 21 curves complete your railroad.

layout be? In the cellar? The attic? A spare room? Sketch in the available space to scale and rough in a few ideas. To help you plan your layout accurately "O" and "027" adhesive track and accessory templates are available free of charge from the Lionel Engineering Department.

When you plan your first track layout, be sure to allow for future growth of your rail system. As you add to your rolling stock you will want more sidings, classification and storage yards, reversing loops, freight and passenger terminals, industrial installations. The simple siding in today's layout may tomorrow become a complete new branch of your railroad empire. The sketches above show a step-by-step transformation from a simple oval to a king-size railroad system.

### Elevate Your Layout

The ideal location for a permanent layout is on a large table or specially built "run-around" wall shelving. Floor layouts risk the perils of stepped-on track, they are awkward to get at and a problem when the floor needs cleaning.

Favorite spots for waist-level train setups are dry cellars, attics, spare rooms and garages. Sketches on the right illustrate simple methods of building wall shelving or tables. Platforms can be cheaply constructed of old lumber or second-hand plywood. Plywood has definite advantages in that it requires little cutting or fitting and simplifies

drilling of holes for hidden wiring. A sheet of celotex over the plywood will help sound-proof your layout. If you construct a table arrangement be sure that the legs are well cross-braced. Wall shelving, too, should be sturdily built to prevent sway and unsteadiness.

One of the principal reasons for the shelf or table layout is to bring model train operation to a realistic-view angle. Although there is some dispute as to the correct height from the floor, the general agreement is that 40 inches is about right for adults, a height of about 26 inches for the seven or eight-year-olds. For a father-and-son layout build a six-inch step to take care of the junior partner.

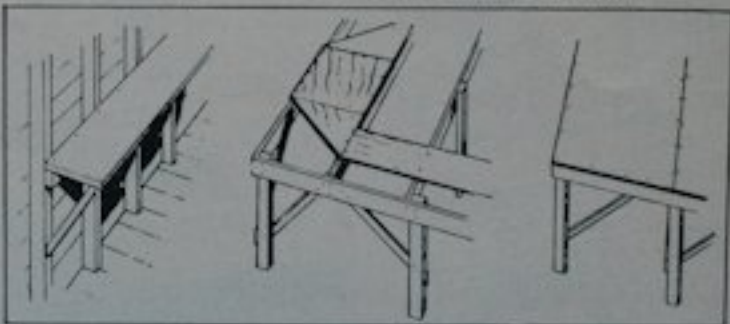

## Building Grades

To take full advantage of Lionel's "Magne-Traction" locomotives and to provide for excitement of overpassing trains you will undoubtedly want to have some graded mountain sections in your layout. Keep the grades as gradual as possible— $\frac{1}{2}$ " rise per section of track is as steep as you should go—and be sure they are anchored securely so that train vibration will not loosen them. The height of an overpass should be about 6".

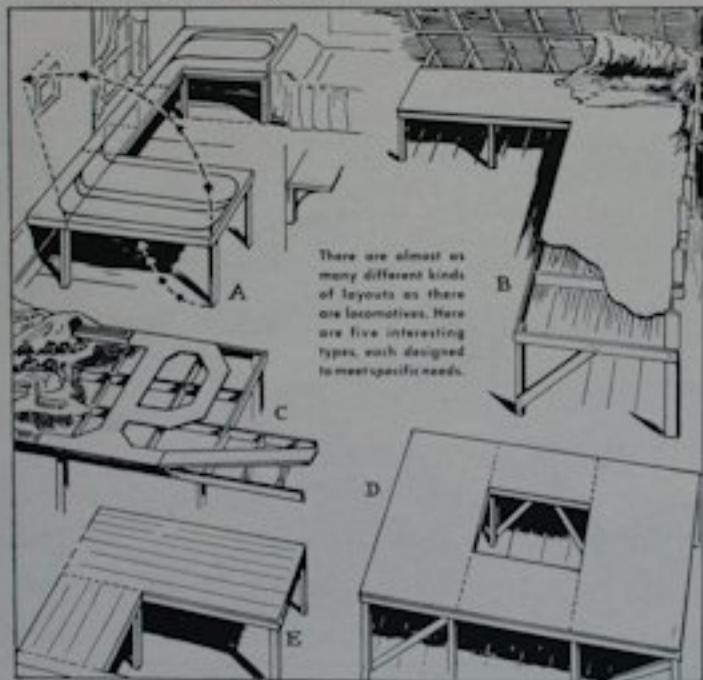

There are almost as many different kinds of layouts as there are locomotives. Here are five interesting types, each designed to meet specific needs.

## Realism with Scenery

"Scenery brings it to life." Yes, landscaping is one of the most important parts of building a model pike. General planning of it should take place at the same time you're figuring out your railway system, and some of the actual work must be done before you lay a single section of track. Mountainous areas, rivers, valleys should be in place before track laying is done, so that working on them will not disturb your roadbed. Location of towns will depend on placing of your industrial siding and passenger stations. Keep in mind that you are developing an entire community and countryside. Everything you place in it should have a reason for being where it is. Sketches on these pages show the steps in landscaping a simple layout.

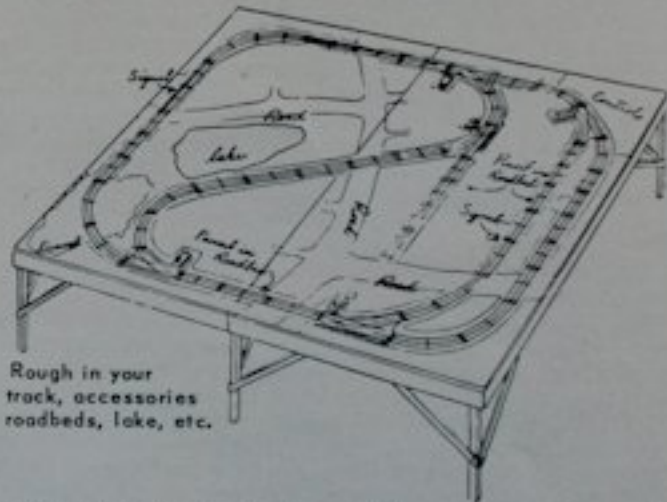

Rough in your track, accessories roadbeds, lake, etc.

First lay out your track, switches and operating equipment as you plan to have them, without nailing them down.

"Clean and Lubricate Your Equipment"



Then, with a pencil, mark off your roadbed with a line about  $\frac{1}{2}$ " outside the ties of the track. Remove track and paint trackbed with thick, grey paint. While paint is still wet sprinkle it with fine ballast stone or sand. After paint has dried, replace track and fasten it down.

The mountain tunnel is built of wood, wire screen and rags. Cut two tunnel portals and wings out of  $\frac{1}{2}$ " pine. After making sure that they give enough clearance for

trains, toenail them into position. You can use old window screen for the entire mountain—crumple it up, tack it to portal openings and down to the platform. No other frame is needed, as the wire is stiff enough to hold its shape. If you want to put an accessory on top of the mountain, flatten the wire out for a plateau. Next stretch old rags over the wire, tacking them down on the platform just as you did the wire. Give the whole surface a coat of cheap varnish or shellac and it's finished, ready to paint.

The lake can be made of blue paper and an old piece of glass. Mount the paper on the platform, then touch it up with brown and green crayons to relieve the "flatness" of the blue. Cover the paper with the piece of glass. To cover the edges of the glass make a "rocky" shore of gravel and stones, held together with "Wall Size Glue." This method can also be used to conceal the edges of your mountains, where wire screen and rags have been tacked down.

There's practically no limit to the different materials you can use for plants and shrubs. Some model builders prefer Norwegian Lichen for trees. "Baby's Breath", sold by florists also makes fine trees, after several small branches have been joined together and have been dipped in green paint and sprinkled with sawdust. Sponges make good shrubs and bushes and can be trimmed to almost any shape. They should be well soaked in water before pieces are torn from them, colored green with tintex dye, and glued into place.

Use paint as the base for your flat sections, too. For fields, lawns, etc., brush with green paint and, while still wet, sprinkle with Lionel No. 919 Artificial Grass. For dirt patches, scatter with yellow sand and gravel. Coffee grounds can also be used to simulate cultivated fields. Highways and roads should also be painted, then sprinkled with fine beach sand. For country roads, score lightly to indicate ruts.

Buildings such as houses, factories, churches can be constructed from plans furnished by model magazines, or from kits available at hobby shops. Once you've got the knack of it you will use your own designs.

Tunnel portals are cut out of wood, nailed together and toenailed to table.



Wire screen is formed over portals - bent to form mountains.



Rags are stretched on frame, nailed and glued.

A lake is easy to make!

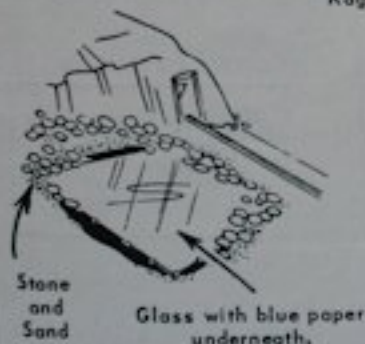

#### MATERIALS USED FOR LANDSCAPING

- 2 lb. box wall size glue
- 1 qt. green paint (light yellow-green)
- 1/2 pt. light brown paint
- 1 pt. dark green paint
- 1/2 pt. yellow paint
- 1 pt. white paint
- 3 paint brushes (2", 1" and 1/4")
- Lionel grass No. 919
- Natural color sawdust
- Pieces of old sponge
- Gravel, Sand, Lichen

## RUNNING A RAILROAD

Most intricate of all model railway systems—and the most exciting of all—is the one that requires the services of a number of operators. Such systems are just the thing for model railroad clubs or for families in which several members all want to participate.

The one shown here is set up for four operators but if space allows it can be easily expanded.

The No. 1 man is engineer of the outside loop train, controlling the train only. No. 2 man is dispatcher and operator of the outside loop, controlling switches, signals and any operating accessories. All semaphores and block signals are remote-controlled by dispatcher, so engineer must watch them carefully in the operation of his train.

The inside loop also has both train engineer and dispatcher-yardmaster. No. 3 man runs the inside loop train, while No. 4 controls track operations and accessories.

Operating this railroad is like this: Engineer No. 1 must

watch his semaphores and block signals. A yellow light on 153A signal tells him to reduce speed to take switch and pass into siding A. Yellow light on 153B (replacing red light on signal) indicates reduced speed to take crossover B.

When crossover switches at B are set to take trains from outside loop, switch C is also automatically set to take train in on track D. This arrangement reverses train so that it runs in the proper direction on inside loop.

Engineer No. 3 must also follow directions of signals controlled by operator 4. When he is to pass out onto the outside loop, he first backs into track D, then through E, thus reversing direction. Then he is ready to take crossover F to outside loop.

No. 2 operator controls lift bridge, water tower, lumber loader, switches and all UCS sections on outside loop.

No. 4 operator controls coal loader, coal ramp, all switches and UCS sections on inside loop.

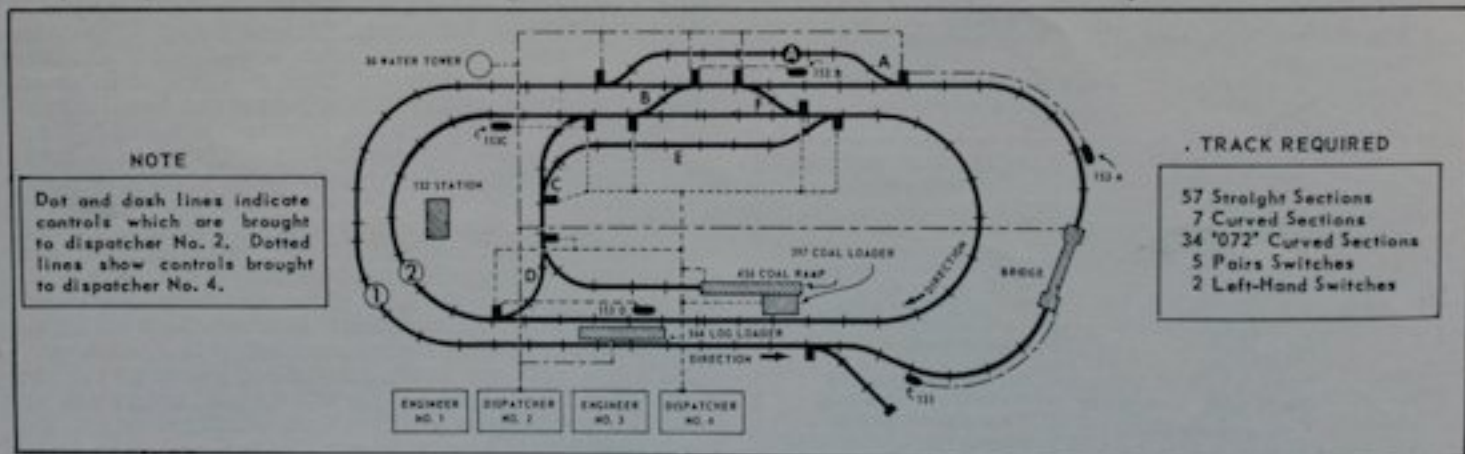

## HOW TO TAKE CARE OF LIONEL EQUIPMENT

Lionel trains and accessories are made of the best available materials and are carefully inspected at every step of production to make sure they reach you in perfect condition. Like all fine mechanical equipment, however, Lionel trains will perform better and last longer if you treat them with proper care.

While complete overhauling and replacement of parts is best done by an Authorized Lionel Repairman, you can do a great deal yourself to keep your trains in good operating order. The most important thing you can do is to clean and lubricate your equipment regularly.

A complete Lubricating and Maintenance Kit No. 927, containing detailed instructions and necessary materials, is available at your Lionel Dealer at \$1.75 and is a good investment for a model railroader.



Lionel No. 927 Lubricating Kit

### Cleaning Your Equipment

All parts of your Lionel outfit which serve as electrical contacting surfaces must be kept clean and free of oil or grease which might act as an insulator. These parts are the rolling surfaces of locomotive and car wheels, the contact rollers and sliders and the track itself. Dampen a clean cloth with Lionel Cleaner or other household cleaner, run it over the surface to be cleaned, then wipe dry. If the rails

"Wipe Your Track Regularly"

or the rail pins have become rusted, good contacting surface should be restored by polishing with fine sandpaper or emery cloth. *Do not* use steel wool because small metal strands get caught on the track and may cause troublesome short circuits. Loose pins should be tightened with a pair of track pliers described on page 37.

Frequently rails and pins become rust-coated during storage, particularly if they are kept in a damp place. A light coat of lubricant spread on the rails before they are stored away will keep them in good condition and free of rust.

To keep your outfit looking new you may want to clean the cars as well. The painted surfaces of car bodies should be cleaned with a cloth saturated with mild soap suds and dried carefully. Do not use any abrasive cleaners and solvents or you will destroy the car markings.

### Lubricating Lionel Trains

Like all fine mechanical equipment, Lionel Trains should be properly lubricated. This will guarantee good operation and prolong the life of your equipment. Proper lubrication does not mean excessive lubrication. Too much oil or grease is just as bad as none at all, because it will gather dust, foul the motor, and get on the wheels and track making them so slippery that the locomotive will not be able to pull the train. Lubricate thoroughly, but sparingly, and wipe off all excess oil or grease.

### Where Not to Lubricate

Some parts of Lionel equipment should not be lubricated at all because oil or grease would interfere with their operation. These parts are:

Motor brushes or the commutator surface of motor armatures;

Track rails or running surfaces of locomotive wheels;

Conveyor belts carrying artificial coal;

Contact rollers of locomotives and cars of the type where the roller turns on a rigidly fixed axle.



## Where to Use Lionel Lubricant

A tube of special non-fluid Lionel Lubricant is furnished with each Lionel outfit. Because this grease-type lubricant does not run, it should be used for all exposed moving parts of locomotives and cars. Such exposed parts, marked by letter L in the sketches on these pages, include gears, ends of pilot wheel axles, truck pivots and guides. Pay particular attention to the exposed ends of armature shafts in locomotives equipped with transversely mounted motors, such as Nos. 2055, 2046, 665, etc. Because these shafts rotate at high rates of speed they require lubrication more frequently than any other part of the locomotive. The armature ends can be easily reached as shown in the illustration below.

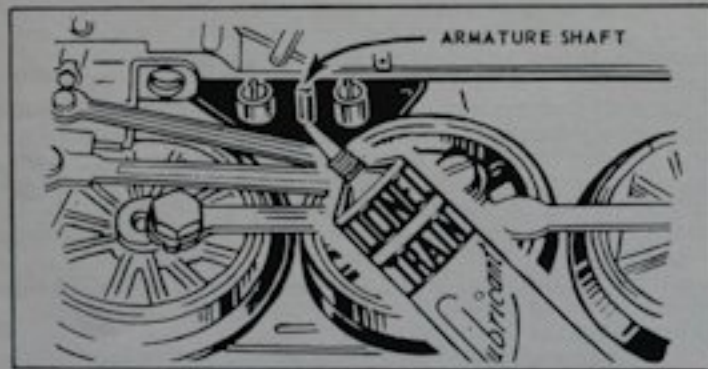

Locomotives where the motor is mounted lengthwise do not require as much attention since they are equipped with large lubricant reservoirs which are filled at the Factory. Locomotives containing motors of this type are Nos. 682, 736 and 2353. Similar motors are used in such accessories as the 364 lumber and 397 coal loaders. A motor equipped with a lubricant reservoir is at top left of next column.

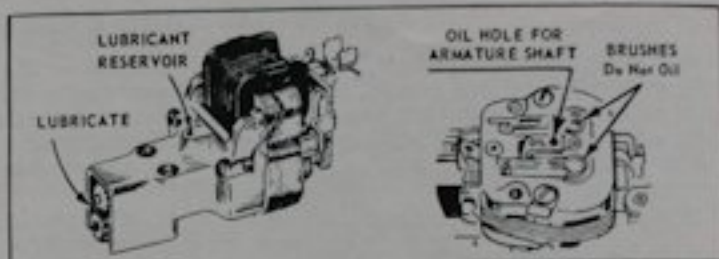

## Where to Use Oil

The driving axles of Lionel locomotives run in porous bronze bushings which are impregnated with oil at the Factory and retain their self-lubricating properties for a long time. This self-contained oil supply can be replenished with a few drops of light motor oil. Oil is also used to replenish oil wicks such as are used to lubricate the armature shafts in the whistle motor and in locomotives No. 623 and 2031. Sketch above right shows a type of motor using an oil wick for lubrication. In applying oil be careful not to get any into the brush wells which adjoin the oil hole. To avoid excessive use of oil, and to direct it only at the desired location, the oil should be applied a drop at a time, using a toothpick or a long wire as applicator.

## Lubricating Car Trucks

Improperly lubricated car trucks may double the drag on your locomotive. Spin the wheels by hand. If they show any signs of drag or binding remove the old lubricant and the accumulated dust and dirt with Lionel Cleaner and apply a dab of fresh lubricant at ends of axles. (Points "L.")

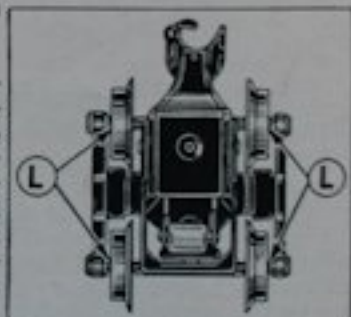

"Clean and Lubricate Your Equipment"

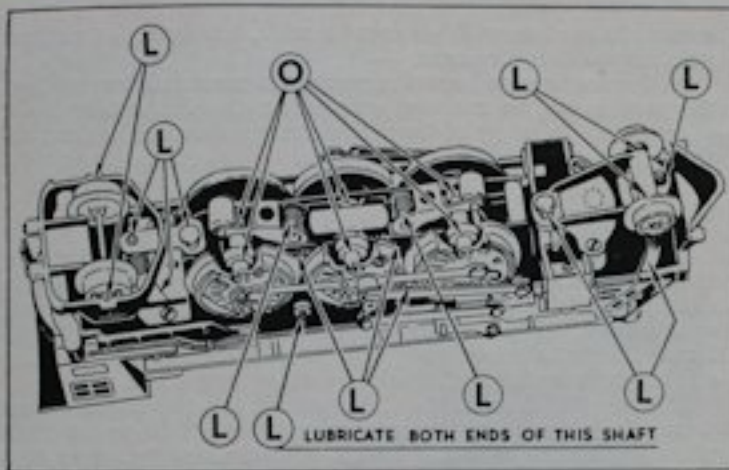

Lubricating Points of a Typical Lionel Locomotive  
Equipped with a Transversely-Mounted Spur Gear Motor

### The Train Whistle

The train whistle is located in the coal tender and can be reached by taking off the body of the tender. The whistle consists of a relay, a whistle chamber, and the whistle

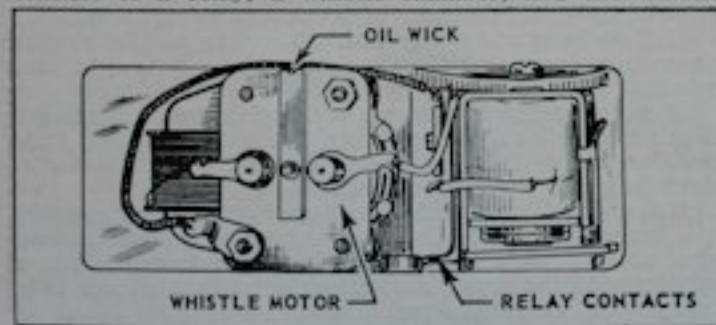

"Wipe Your Track Regularly"

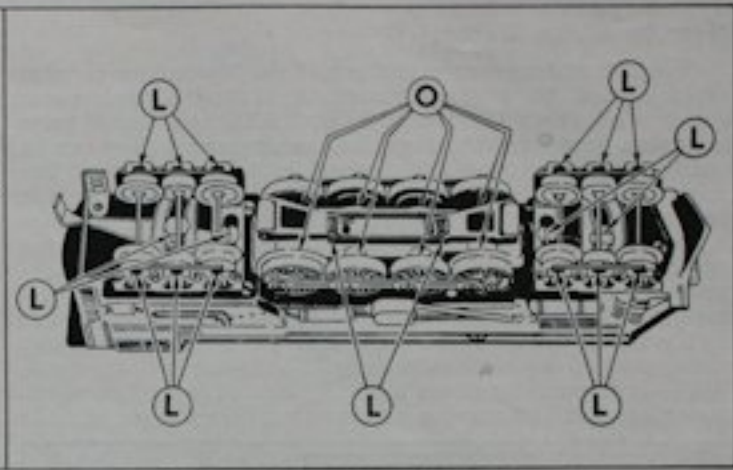

Lubricating Points of Lionel No. 662 Locomotive  
in which the Motor is Mounted Lengthwise

motor. The motor is similar to other Lionel motors and is cleaned in the same way, although the brush plate must be removed to reach the commutator. The oil wick which lubricates the armature shaft of this motor is contained in a long housing on top of the brush plate. To lubricate take out the wick, dip it in light machine oil, squeeze out the excess oil gently and replace the wick. Whistles of the latest type are equipped with self-lubricating bearings and have no wicks.

### Replacing Headlight Lamps

If the bulb in the locomotive headlight or in an illuminated accessory does not light, first check to see that the bulb is tight in its socket. If the lamp is burned out you can easily replace it yourself by obtaining a spare from your dealer. The chart on the inside of the back cover lists replacement lamps for all modern Lionel equipment.

## How to Clean Motors

Sluggish and uneven operation of the locomotive is most often caused by a dirty motor. A typical Lionel motor consists of parts illustrated below. Although these parts may vary somewhat in shape and arrangement they can be easily recognized and are cleaned in the same way. The most important part to be cleaned is the *commutator*, the segmented copper surface on which the carbon *brushes* make their contact. The commutator can be easily seen and reached for cleaning on locomotives having a transversely-mounted motor. To polish the commutator turn the locomotive on its side and connect one wire from transformer to the locomotive contact roller and the other wire to any metal part of the locomotive body. The motor will then run. While it is running press a small piece of very fine sandpaper against the moving commutator. Then clean out the

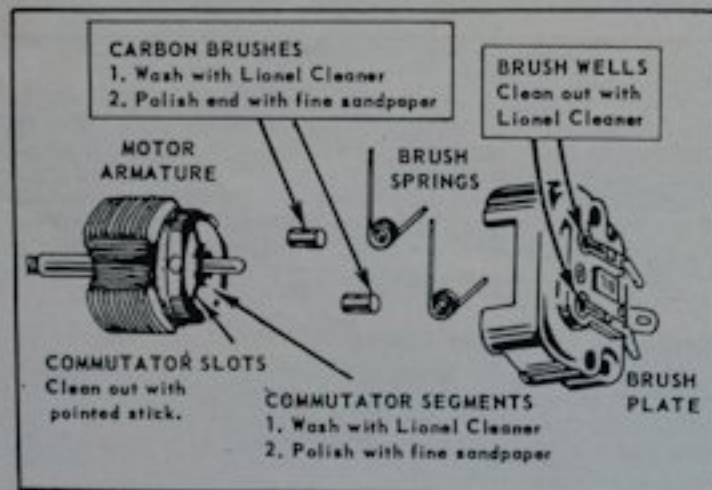

commutator slots with an orange stick, toothpick, or similar pointed wood instrument.

In locomotives where the motor is mounted lengthwise, the motor can be reached only after the locomotive body is removed. In many of them the commutator can be reached through a hole in the brush plate.

## Motor Trouble Shooting

If your train refuses to run, first make sure that the transformer is plugged in and that you are getting current from the transformer output terminals. Then see that all connections on transformers and track are correct and firmly fastened. See that the steel pins inserted at the end of each section of track are clean and tight.

If train still does not run, disconnect the two transformer wires from track. Prop locomotive right side up so that wheels are free to turn. Touch one of these wires to any unpainted part of the motor frame. With the other wire touch the contact shoe which collects the current from the center rail of the track. If motor still does not operate, it may be that the reversing unit is in neutral position. If the E-Unit is in neutral position, the locomotive will not run, although its headlight will be on. Try the above procedure with different adjustments of the reversing unit lever.

If the wheels move very slowly, cleaning and lubricating the motor may be all that is necessary to restore original power.

If motor starts and stops, or if wheels do not revolve, look for loose connections. See if the carbon brushes make good contact with commutator. Clean the commutator as described in a previous section.

If the wheels revolve freely there is nothing wrong with the locomotive motor. The trouble may be that the contact shoe rollers do not have enough tension to make proper contact with the center rail. If contact rollers appear to be badly worn, have them replaced.



# LIONEL SERVICE STATIONS

look for the  
factory seal  
of approval



1954-1955

**Only Lionel Approved Service Stations are authorized to service warranted merchandise**

When returning articles for service either to the Lionel Service Department or to any authorized Service Station, please send only those articles which you believe to be inoperative. There is no need to return the complete outfit when the trouble is in the locomotive only.

**THE LIONEL CORPORATION—SERVICE DEPARTMENT**  
28 SAGER PLACE IRVINGTON 11, NEW JERSEY

## LIONEL SERVICE POLICY

Lionel Products are guaranteed against defects in material and workmanship to the extent that if any such defective article is returned to the Lionel Service Department or to any Lionel Authorized Service Station within a year of the date of purchase it will be repaired or replaced.

If any of your equipment needs servicing you may send it either to the Factory Service Department or to any Lionel Approved Service Station.

Although the Lionel Approved Service Stations listed in the following pages are independently owned and operated, each has been carefully checked by The Lionel Corporation for reliability. These Service Men are experts and most of them have been adjusting and repairing Lionel equipment for many years. Lionel Authorized Service Station approval is not permanent but has to be renewed from year to year to assure continuing high standard of service.

In addition, The Lionel Corporation maintains two large Service Stations of its own. One is at 15 East 26th Street, New York 10, New York, and the other is at 28 Sager Place, Irvington 11, N. J.

*The Lionel Corporation assumes no responsibility, financial or otherwise, for material left or work done by privately-owned Lionel Approved Service Stations. Any complaints brought to our attention will be quickly investigated.*

# LAMP REPLACEMENT CHART

Cat. No.	Item	Volts	Color	Lamp No.	Price
022	"O" Switch	18	Clear	L1445	.25
022C	Switch Controller	18	Red	L432(R)	.20
		18	Green	L432(G)	.20
042	"O" Switch	18	Clear	L1445	.25
71	Lamp Post	14	Clear	L363	.20
132	Station	14	Clear	L431	.15
140	Banjo Signal	12-18	Red	L53(R)	.25
145	Gateman	14	Clear	L431	.15
151	Semaphore	12-18	Clear	L53	.20
153	Black Signal	12-18	Red	L53(R)	.25
		12-18	Green	L53(G)	.25
154	Highway Signal	12-18	Red	L53(R)	.25
157	Station Platform	6-8*	Clear	L51	.15
193	Water Tower	6-8	Clear	L51	.15
252	Crossing Gate	14	Clear	L363	.20
256	Freight Platform	14	Clear	L431	.15
260	Bumper	14	Clear	L363	.20
358	Freight Station	14	Clear	L431	.15
364	Lumber Loader	14	Clear	L363	.20
395	Floodlight Tower	6-8*	Clear	L51	.15
445	Switch Tower	14	Clear	L363	.20
		12-16	Red	L53(R)	.25
450	Signal Bridge	12-16	Green	L53(G)	.25
		14	Clear	L363	.20
456	Coal Ramp	14	Clear	L363	.20
494	Rotary Beacon	14	Clear	L363	.20

Cat. No.	Item	Volts	Color	Lamp No.	Price
623-4	Diesel Switchers	14	Clear	L363	.20
665	Locomotive	12-16	Clear	L57	.20
682	Locomotive	18	Clear	L1447	.25
685	Locomotive	18	Clear	L1445	.25
736	Locomotive	18	Clear	L1447	.25
1130	Locomotive	14	Clear	L363	.20
1122	"027" Switch	12-16	Clear	L53	.20
1122-100	Switch Controller	12-16	Clear	L53	.20
2026	Locomotive	18	Clear	L1445	.25
2031-2-3	Diesel Locomotives	14	Clear	L363	.20
2037	Locomotive	18	Clear	L1445	.25
2046	Locomotive	18	Clear	L1445	.25
2055	Locomotive	18	Clear	L1445	.25
2065	Locomotive	12-16	Clear	L57	.20
2321	F-M Diesel	12-16	Clear	L57	.20
2245	Diesel Locomotive	12-16	Clear	L57	.20
2353-4-5	Diesel Locomotives	18	Clear	L1447	.25
2432-4-5-6	Pullman Cars	6-8*	Clear	L51	.15
2531-2-3-4	Streamline Cars	12-16	Clear	L57	.20
3620	Searchlight Car	14	Clear	L363	.20
6250	Diesel Switcher	14	Clear	L363	.20
6357	Caboose	14	Clear	L431	.15
6417	Caboose	14	Clear	L431	.15
LTC	Illuminated Lockon	18	Clear	L1445	.25
	TW Transformer	12-16	Clear	L53	.20
	Transformers(except TW)	6-8	Clear	L51	.15

\* In these installations the lamps are placed in "series".

This chart lists all illuminated equipment produced in 1954. For replacement lamps used in earlier equipment consult your Approved Service Man or the Factory Service Department.

# LIONEL TRACK LAYOUT

## PRINTING KIT

Now make your own Track Layouts — hundreds and hundreds of them — all sizes — all types — from the simplest to the most elaborate — with this newly created LIONEL TRACK LAYOUT PRINTING KIT. No longer need you guess at what type layout will fit your space. You can lay out your pike in a jiffy on paper and see exactly how much track and what switches and cross-overs you require.



# 25¢

This printing kit also contains special track layout and landscaping information for your guidance. This kit can be used for both "0" and "027" track.

